

SemiChem APM 200, Dual Cell Floor Mount with Grabport

Installation and operating manual for model 009672



TABLE OF CONTENTS

Section 1: Introduction	4	3.6 Recirculating Bath Configuration	14
1.1 About the Manual	4	3.7 Signal Connections.....	15
1.1.1 Scope.....	4	3.7.1 Inputs and Outputs.....	15
1.1.2 General Notes	4	3.7.1.1 Ethernet.....	15
1.2 Product Overview	4	3.7.1.2 RS232.....	15
1.2.1 Process and Instrumentation Diagrams..	5	3.7.1.3 USB.....	15
Section 2: Safety	7	3.7.1.4 Analog/PLC Handshaking.....	15
2.1 Risk Analysis.....	7	3.8 Installation Notes.....	15
2.2 Safety Related Policy.....	7	Section 4: Unit/System Operation	16
2.3 Chemical Safety	7	4.1 Main Screen	21
2.4 Signal Word Definitions	7	4.2 Service Screen	21
2.5 Process Compatibility	8	4.2.1 Login and Passkey.....	21
2.6 Reagent Handling	8	4.2.2 Settings	22
2.7 System Ventilation	8	4.2.3 Recipes	22
2.8 Electrical Safety	8	4.2.4 Calibration.....	23
2.9 Emissions	9	4.2.5 Diagnostics	23
2.10 Ergonomics.....	9	4.3 Errors and Analysis Troubleshooting	24
2.11 Flammability.....	9	4.4 Analysis Curves For Troubleshooting.....	25
2.12 Potential Failure and Trouble Spots.....	9	4.4.1 Titration Analysis.....	25
2.13 Safe Standby Mode.....	9	4.4.2 Standard Addition Analysis (ISE's).....	27
2.14 Chemical Locations	10	4.5 Hardware Troubleshooting.....	28
2.15 Potentially Hazardous Maintenance	10	4.5.1 System Shutdown and	
2.16 Spill Prevention.....	10	Decon Procedures.....	29
2.17 Environmental Issues and Waste Treatment....	11	4.5.2 Electrical Module Troubleshooting.....	30
2.18 Exhaust Treatment.....	11	4.5.2.1 Electrical System	
2.19 Secondary Containment.....	12	Visual Indicators	30
Section 3: Installation	12	4.5.3 Burette System Troubleshooting.....	32
3.1 Overall System Dimensions.....	12	4.5.3.1 Potential Symptoms	32
3.2 Choosing A Location	13	4.5.3.2 Burette Assembly.....	32
3.3 Required Utilities	13	4.5.3.3 Burette Operational Test.....	32
3.4 Receipt and Unpacking	14	4.5.3.4 Burette Visual Indicators	32
3.5 Mounting the SemiChem APM 200.....	14	4.5.4 Sensor Troubleshooting	35
3.5.1 Installation Clearances	14		

Section 5: Options	36
5.1 History	36
5.2 Customer Interface	37
5.2.1 Analog Outputs.....	37
5.2.2 PLC Handshaking/Recipe Selection.....	37
5.2.2.1 PLC Handshaking Procedure Without Recipe Select	37
5.2.2.2 PLC Handshaking Procedure With Recipe Select.....	37
5.2.3 RS232 Communications	38
5.2.3.1 RS232 Inputs.....	38
5.2.3.2 RS232 Output	38
5.2.3.3 Ethernet Networking	38
Section 6: System Diagrams and Mechanical Drawings	39
6.1 Illustrated Parts Guide.....	39
6.2 Facility Drawing	44
6.3 Wiring Diagram – AZ011068 "Standard".....	47
6.4 Wiring Diagram – AZ011496 "FM4910" and "NON-FM4910"	51
Section 7: Maintenance	55
7.1 Preventive Maintenance.....	55
7.1.1 Weekly Maintenance	55
7.1.2 Monthly Maintenance.....	55
7.1.3 Quarterly Maintenance.....	55
7.1.4 Annual Maintenance	55
7.1.5 Bi-Annual Maintenance.....	55
7.2 Replacing the Burette O-Rings.....	55
7.3 Replacing the Jacketed Style Burette O-Ring.....	56
7.4 Lock-out Tag-Out.....	57
7.4 SemiChem APM 200, Dual Cell Floor Mount Start-Up Kit.....	58

SECTION 1: INTRODUCTION

1.1 ABOUT THE MANUAL

1.1.1 Scope

This manual covers the SemiChem Advanced Process Monitor (APM) 200, Dual Cell Floor Mount with Grabport System, model 009672. The information contained herein is the property of Entegris. Use only the most current revision of this manual. The information in Entegris' published engineering specifications, manuals, and guides are correct as of publication date. Entegris is not responsible for product application, including but not limited to compatibility with other equipment.

No part of this manual in part or in whole may be reproduced or transmitted in any form or by any means, electronic, mechanical, or magnetic, including but not limited to photographing, photocopying, recording, or any information storage and retrieval system, without the written permission from Entegris.

1.1.2 General Notes

The manufacturer reserves the right to make changes to the products described in this manual to improve performance, reliability, or manufacturability. The descriptions of features and procedures found in this manual may include inaccuracies due to new changes or inadvertent errors and are subject to change without notice. Contact Entegris for updates, corrections, or clarifications.

1.2 PRODUCT OVERVIEW

Our SemiChem APM 200 is a wet chemical monitoring system that automatically samples, analyzes, and reports quantitative chemical concentration of critical processes. Full, on-line chemical monitoring allows real-time correction of bath composition and therefore stable control of the process conditions. The system provides class-leading chemical concentration data. When immediately apparent, variations that can negatively affect product quality can be quickly corrected, helping to meet the demands for zero defect tolerance and higher product yields.





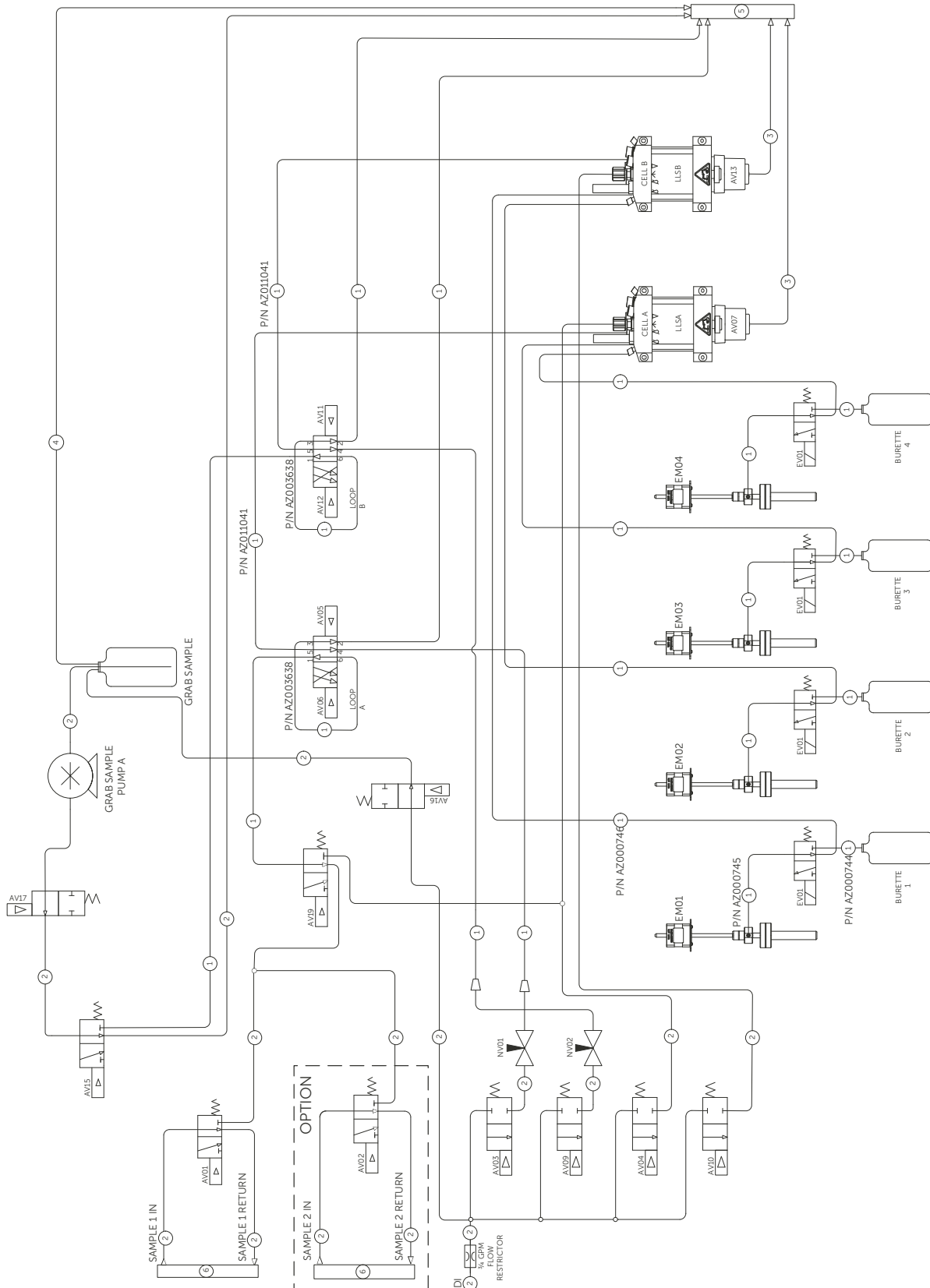

SemiChem APM 200, Dual Cell Floor Mount with Grabport, Model 009672.

1.2.1 Process and Instrumentation Diagrams



Keyed notes

	1/8" OD PFA tubing
	1/4" OD PFA tubing
	1/4" PFA flare fitting
	1" FNPT
	3/8" OD PFA tubing

24 VDC digital outputs

AV01	Sample 1 valve
AV02	Sample 2 valve
AV03	Loop A transfer
AV04	Cell A flush
AV05	Loop A open
AV06	Loop A take
AV07	Cell A drain
AV08	Cell A overflow
AV09	Loop B transfer
AV10	Cell B flush
AV11	Loop B open
AV12	Loop B take
AV13	Cell B drain
AV14	Cell B overflow
AV15	Grab sample
AV16	Grab flush
AV17	Anti-siphone
EV01	Burette 1 mini 3/2
EV02	Burette 2 mini 3/2
EV03	Burette 3 mini 3/2
EV04	Burette 4 mini 3/2
Pump A	Cell A drain pump
Pump B	Cell B drain pump

Digital input

LLSA	Cell A level sensor
LLSB	Cell B level sensor

SECTION 2: SAFETY

This section highlights key safety and ergonomic issues related to using the SemiChem APM 200. Matters addressed include risk analysis, chemical safety, electrical safety, flammability, and ergonomics.

2.1 RISK ANALYSIS

Using the SemiChem APM 200 has inherent safety risks, including fluidics hazards, chemical hazards, and electrical hazards. Fluidics hazards come from pressurized sample and air lines. Chemical hazards include the hazards associated with the sample and various reagents used by the analyzer. Electrical hazards include the high voltage (110/220 VAC) located within the electrical compartment.

2.2 SAFETY RELATED POLICY

As a matter of policy, Entegris provides end user information about any safety related upgrades or newly identified hazards with the SemiChem APM 200 should it become necessary. End users are informed of safety-related issues through "Safety Updates" that are published periodically and distributed to all applicable end users.

The end user and their subcontractors must be responsible to assure that their respective employees receive hazardous communication training that meets or exceeds OSHA 29CFR 1910.120 (hazardous waste operations and emergency response). End users and their subcontractors who work on the SemiChem APM 200 are required to assure that their respective employees are provided with material safety data sheets from their Environmental Health and Safety (EHS) department for all chemicals that pass through the SemiChem APM 200.

It is imperative that when working on any piece of equipment, the service technician follows all policies, practices, and procedures established by the end users' EHS group.

2.3 CHEMICAL SAFETY

MSDSs for the reagents used within the SemiChem APM 200 can be provided upon request. In most cases, chemicals contained within the processing tools themselves are available with the end user's EHS department. The user is responsible for obtaining process related MSDSs and should contact the supplier. MSDSs for chemicals used as reagents can also be obtained by the reagent supplier.

These reagents used in the process should be replaced when empty or system alarms that low levels are present.

Reagents

Reagent, 6.0N sulfuric acid (4 L)

Reagent, 1N ceric ammonium sulfate in 2N sulfuric acid (4 L)

Reagent, 5.0N sodium hydroxide (4 L)

Reagent, TISAB II





Reagent, 1000 ppm fluoride standard

Customer Sample

500 ppm HF, 10% H₂SO₄, and 4% H₂O₂, 0 – 2% H₂O₂

2.4 SIGNAL WORD DEFINITIONS

The following signal words designate a degree or level of safety alerting:

-  **DANGER:** Indicates an immediate hazardous situation which, if not avoided, will result in death or serious injury.
-  **WARNING:** Indicates a potentially hazardous situation which, if not avoided, could result in death or serious injury.
-  **CAUTION:** Indicates a potentially hazardous situation, if not avoided, may result in a minor or moderate injury. It may also be used to alert against unsafe practices.
-  **NOTICE:** Indicates a statement of policy directly or indirectly related to personnel safety or property protection.

Below are examples of applicable safety alert pictorials:

Safety alert	
Corrosive	
Electrical	
Flammable	
Poison	
Eye protection	
Hand protection	
Personal protective clothing	

2.5 PROCESS COMPATIBILITY

All components are compatible with the sample/reagents that they contain. All sample wetted materials are PFA, PTFE, PVC, acrylic, or glass. Wetted materials are designed to withstand a maximum pressure of 40 psi (2.76 bar) and a temperature range of 4.5° – 66°C (40° – 150°F). If you anticipate sample pressures or temperatures in excess of these values, contact Entegris for upgrade instructions.

⚠ WARNING: Only operate the SemiChem APM 200 within the pressure and temperature limits specified. Failure to do so can cause leaks and chemical spills.

2.6 REAGENT HANDLING

Most reagents used with the SemiChem APM 200 will present some level of hazard. It is the responsibility of the end user to investigate and use all appropriate precautions while handling reagents. Please be sure to possess and review the MSDS of each reagent prior to handling. For more information, contact either the Environmental and Health department or the reagent supplier. Entegris takes no responsibility or liability for the reagents and their handling.



Use the table below to identify each reagent and reagent concentration.

Table 2.1 Reagent locations

Reagent/Burette #1
Reagent/Burette #2
Reagent/Burette #3
Reagent/Burette #4
Other Reagent
Electrode Fill Solution

2.7 SYSTEM VENTILATION

The SemiChem APM 200 should be properly ventilated. The exhaust requirements are:

- Duct material to be of nonflammable construction and compatible with hazardous fumes when applicable.
- Measurements of exhaust velocity and ventilation static pressure are to be made in the exhaust collar.
- Ventilation static pressure for the SemiChem APM 200 is to be -2 inches of water column; the exhaust interlock switch is preset to trip with an exhaust failure.
- Exhaust flow and volumes can be found in the Facility Matrix in Section 3, Installation.

2.8 ELECTRICAL SAFETY

The SemiChem APM 200 contains type 3. Other areas of the SemiChem APM 200 may contain type 3 hot work.

Tools are required to enter any area of the SemiChem APM 200 that contains electrical connections. Areas of the SemiChem APM 200 containing type 3 hot work require a 3/32" ball driver for entry.

SemiChem APM 200 is provided with a line cord and 3-prong plug for connection to the local power outlet. The SemiChem APM 200 has been designed with a removable power cord. Entegris provides the power cord that is suitably rated for the SemiChem APM 200. If another cord is used, it must be rated for the power input of the SemiChem APM 200 at 1 AMP, 250 VAC.

2.9 EMISSIONS

The SemiChem APM 200 does not emit or generate hazardous levels of ionizing/non-ionizing radiation or audio noise.

2.10 ERGONOMICS

Ergonomic factors such as the height and weight of the analyzer do not pose a significant hazard. The height of the analyzer should be at a comfortable level, with the user interface about 60 inches off the ground. At this height, all areas can be accessed comfortably.

Each of the four-liter reagent containers can weigh up to 10 pounds when full. Care should be exercised when lifting, removing, and installing these containers.

⚠ WARNING: The SemiChem APM 200 floor mount system weighs nearly 169 pounds dry. Please note its weight when installing or moving the system.

2.11 FLAMMABILITY

All high voltage ($110/220$ VAC) is contained within an enclosure rated for flammability at a UL 94VO rating. Low voltage and chemicals are contained within an enclosure rated for flammability at both UL 94VO and/or as a special order FMRC 4910.

2.12 POTENTIAL FAILURE AND TROUBLE SPOTS

Potential key failure points and trouble spots can include, but are not limited to:

- Chemical exposure due to leaking fittings
- Chemical exposure due to broken glass burettes
- Chemical exposures due to maintenance activities
- Potential electric shock from servicing electrical components

Methods to avoid potential hazards include the use of personal protective equipment, various system level safety interlocks, and administrative controls. Potential key failure points and trouble spots are identified by text, such as DANGER, CAUTION, and/or WARNING accompanied by pictorials identifying the potential hazard such as POISON, ELECTRICAL, FLAMMABLE, and/or CORROSIVE.

2.13 SAFE STANDBY MODE

Safety interlocks have been designed so that an operator can quickly place the system into a safe standby mode. Safe standby mode is when all pressurized fluid lines (such as reagent and sample lines) are depressurized, and the system aborts the current analysis routine.

An operator can place the SemiChem APM 200 into safe standby mode by violating any of the system interlocks. These interlocks are:

- System exhaust flow detector, which verifies that the system is being properly exhausted to the facility exhaust system.
- Leak detector, which detects any leak within the analyzer's enclosure.
- Emergency Machine Off (E.M.O.) button, which de-energizes 24 VDC at the safety interlock PCB.
- Door interlock, which will place the system into a safe standby mode when the door is opened.

When the safety interlock is activated, the following sequence is initiated:

1. The 110/220 VAC power is confined to the rear of the electrical compartment.
2. The "secondaries", or low voltage, is opened.
3. All electrical within the wet module is shut down.
4. All chemical lines are isolated. Alarm Relay 2 is closed to signal external equipment to stop sample flow. Note: if external safety interlock fault signal is not used by the external equipment, sample may still be present in the SemiChem APM 200.
5. Isolated lines and inactive burettes will not allow chemicals to enter the SemiChem APM 200.
6. The safety circuitry remaining intact to visually display which interlock or combination of interlocks was activated, and in the case of exhaust and leak, a visual and audible tone.
7. The SemiChem APM 200's PLC Handshaking Relay 1 READY signal is opened to indicate the system is not ready for an analysis.

During maintenance activities, the safety interlocks may be overridden via the override key-switch located on the electrical facility panel. It is important to disengage this override once maintenance activities are completed.

To return to safe operating mode, whichever interlock violation must be resolved and the safety interlock restoration button must be depressed. The safety interlock restoration button is the illuminated green button on located below the EMO button.

2.14 CHEMICAL LOCATIONS

Make a note here of the chemical locations (including their concentrations) in your SemiChem APM 200:

SYSTEM LOCATION	CHEMICAL NAME AND CONCENTRATION
Burette #1 and Reagent #1	
Burette #2 and Reagent #2	
Burette #3 and Reagent #3	
Burette #4 and Reagent #4	
Sensor #1 fill solution	
Sensor #2 fill solution	

The reaction vessels may contain DI water, reagents, reaction byproducts, and sample. The sample lines may contain sample from the process.

2.15 POTENTIALLY HAZARDOUS MAINTENANCE

When performing maintenance on the SemiChem APM 200, purge all sample lines with deionized water to prevent exposure to hazardous chemicals. Also, when performing maintenance on the reaction vessel or sensor, be sure to flush the reaction vessel with DI water to limit exposure to any possible reagent or sample residue. Follow the procedures in Section 4, System Shutdown and Decon Procedures (4.5.1) to fully decontaminate the system of all chemicals.

WARNING: Failure to rinse the piping and tubing system with water prior to any maintenance activity may result in chemical exposure.

Maintenance activities can expose personnel to chemical hazards. These activities can include, but are not limited to:

- Maintaining the digital burettes
- Replacing or refilling reagent levels

WARNING: Corrosive or poisonous liquids. Some reagents may be corrosive to the eyes, skin, and respiratory tract and may be hazardous if ingested. Wear chemical resistant gloves, face shield, and apron when changing the burette O-ring. See MSDS for further health hazard information. To minimize chemical exposure, purge the burette with air by removing the reagent intake line from the reagent bottle, then flush the appropriate burette. This will remove most of the reagent from the burette assembly. If replacing the burette glass, consult with on-site environmental personnel for proper disposal of remaining reagents. If replacing a burette O-ring, keep the burette glass assembly within the enclosure for proper exhaust of fumes.

WARNING: Corrosive or poisonous liquids. Some reagents may be corrosive to the eyes, skin, and respiratory tract and may be hazardous if ingested. Wear chemical resistant gloves, face shield, and apron when replacing or refilling the reagent levels. See MSDS for further health hazard information. When refilling the reagent bottle, remove the bottle from the reagent chamber and bring to a suitable fume hood. Pour the reagents under the fume hood to limit chemical exposure.



- Prior to opening the enclosure door/panel, check to be sure that the enclosure's drain is functioning correctly and that as much of the liquid as possible has drained out of the enclosure.
- Open the affected chamber as briefly as possible (the rear area requires tools) and clean up the remaining liquid. If spill absorbent materials are used, place them in the enclosure and close the door/panel. Open the door/panel and remove once the absorbent material has had time to work.

NOTE: If time permits and the remaining liquid residue is minor, let the remaining liquid evaporate in lieu of opening the enclosure and manually cleaning the spill.

2.17 ENVIRONMENTAL ISSUES AND WASTE TREATMENT

Environmental issues include consideration of sample volumes, wastewater effluent, exhaust effluent, and chemical process efficiencies. Make a note here of the typical sample composition (including concentration):

Component #1

Component #2

Component #3

Component #4

Component #5

Usually around 20 mL of this sample is sent to drain during each analysis. Other waste from the SemiChem APM 200 will include byproducts of the analysis reactions, make a note of the reactions here:

Reaction #1

Reaction #2

Reaction #3

Reaction #4

The waste from the analyzer will include the reaction byproducts created by the analysis of the sample volume, per the reactions above.

The SemiChem APM 200's drain lines should be connected to a waste collection system similar to the waste collect system connected to the associated process tool. This will allow for the collection of the small amount of sample bleed off, the dilute reaction chemistry, and any accidental release of sample or reagent chemicals.

Between 1 and 10 mL of each reagent are typically used during each analysis. Make a note of the estimated usage rates below:

REAGENT	NAME AND CONCENTRATION	ML PER ANALYSIS

Much of the reagent is consumed in reaction with the sample. Overall, chemical consumption is minimized because reagent concentrations and sample volumes are optimized whenever possible.

Sample, DI water, and/or reagents only enter the waste system when an analysis is occurring. There is no discharge of heavy metals, except for those that already exist in the sample stream and specified reagents.

2.18 EXHAUST TREATMENT

Chemicals would only be present in the exhaust from the SemiChem APM 200 and its reagent chamber during an accidental release such as a fluid line rupture, a leaking fitting or a broken container.

It is believed that the emissions from these enclosures during such a release would be minimal. However, only the end user can make a determination as to whether such emissions should be exhausted to an acid scrubber or alternatively, to some general exhaust system which is untreated prior to release into the outdoor environment.

2.19 SECONDARY CONTAINMENT

The SemiChem APM 200 has been designed for secondary containment in the event of a leak. The SemiChem APM 200's volume is more than 110% of the reagent container volumes.

SECTION 3: INSTALLATION

3.1 OVERALL SYSTEM DIMENSIONS

SemiChem APM 200, Dual Cell Floor Mount with Grabport

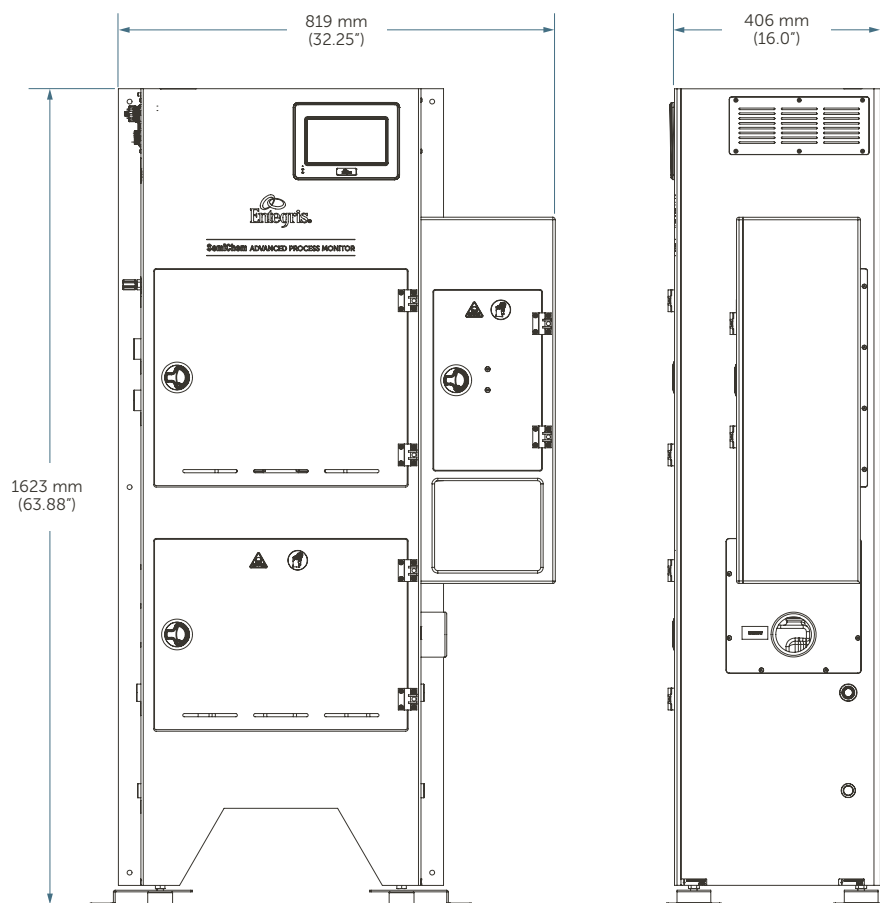

3.2 CHOOSING A LOCATION

The location of your analyzer can significantly impact the success of its installation. Proper location will save a lot of trouble later on. Factors such as the size of the analyzer/reagent containers, their proximity to the process, the location of utilities, possible EMI/RF interferences, and access to the system by fab personnel all need to be carefully considered.

The SemiChem APM 200 is not suitable to be installed in wet locations.

The SemiChem APM 200 is generally installed in a service chase adjacent to the process, or perhaps in the subfab. Ideally, the SemiChem APM 200 would be located near the process or distributions tool's pumps, piping, and drains. In other cases, the SemiChem APM 200 is installed inside the process or distribution tool.

The SemiChem APM 200 should be located indoors in a temperature range of 10° – 35°C (50° – 95°F), relative humidity of 35 – 50% , and an altitude no greater than 2000 m. Installation can be either on a recirculating, non-recirculation, or a blend/distribution system. The SemiChem APM 200 should be installed in a pollution free environment.

⚠ NOTICE: If any additional Seismic Evaluation information is needed, please contact an Entegris Customer Service Representative.

3.3 REQUIRED UTILITIES

Prior to delivery, your SemiChem APM 200 has been fully tested on simulated chemistry. After tests were completed the system was cleaned, dismantled, its lines drained, and all components carefully packaged for protection. Reassembly and startup can be accomplished within one or two hours with proper preparation. The utilities required are:

Table 3.1 Facility matrix

Utility	Location	Type	Flow or current	Pressure or voltage	Notes
Power	Electrical facility panel	Removable power cord	Less than 1.0 AMP	100/240 VAC field switchable	50/60 Hz SCCR 10kA
DI water	Left side of cabinet	¼" OD flare	2.0 liters/min	20 – 40 psi	SemiChem APM 200 does not provide a DI loop
Process drain	Refer to install drawing	¾" FPT			Must be free flowing gravity drain
Cabinet drain	Refer to install drawing	½" FPT			Do not connect to process drain
Sample inlet	Refer to install drawing	¼" OD flare	0.5 liters/min	Less than 40 psi	Through 1" FPT secondary containment
Sample return	Refer to install drawing	¼" OD flare	0.5 liters/min	Less than 40 psi	Must be returned to lower pressure
Reagents	Reagent storage				
Signals	Refer to wiring diagrams				
Exhaust floor mount	Refer to install drawing	3½" OD stub	50 C.F.M.		

When plumbing the SemiChem APM 200 to your process, be sure the sample return goes to a lower pressure location than the sample inlet, to ensure consistent flow through the sampling "fast loop". This is normally accomplished by using the discharge of a recirculating pump to feed the SemiChem APM 200 and allowing the sample to return into either an open bath or process tank.

3.4 RECEIPT AND UNPACKING

⚠ NOTICE: Entegris shall not, under any circumstances, be liable to buyer or any other party for lost profits, diminution of goodwill, or any other special or consequential damages with respect to any claim. In addition, Entegris liability for warranty claims shall not, in any event, exceed the invoice price of the product claimed defective, nor shall Entegris be liable for delays in replacement or repair of product.

To ensure safe arrival of your SemiChem APM 200, specially-constructed packaging has been developed.

Open the top of the packaging and you will find a gray plastic container containing your start-up kit. Set this aside for the time being. The SemiChem APM 200 requires a two-person lift for moving or installation.

⚠ NOTICE: Report any broken, damaged, or missing parts immediately to Entegris at 480-889-0263.

3.5 MOUNTING THE SEMICHEM APM 200

The SemiChem APM 200 is designed to be floor mounted but **MUST** be secured to a stationary structure such as a wall or "UNISTRUT" system. Refer to the installation drawings for dimensions and facility locations.

3.5.1 Installation Clearances

For maintenance of the SemiChem APM 200, observe the following clearances.

Table 3.2 Maintenance clearances

Top	3' (90 cm)
Left	3' (90 cm)
Right	3' (90 cm)
Front	4' (120 cm)

3.6 RECIRCULATING BATH CONFIGURATION

The most common installation involves sampling from a bath or tank that has a circulating pump. A proportion of the sample is simply bled from the recirculation system and fed to the SemiChem APM 200. Sample enters SemiChem APM 200's sample panel, passes briefly through its 3/2-way sample valve, and then returns to the process tool. This is sometimes referred to as a "fast-flow" sampling system.

This "fast-flow" concept minimizes chemical waste and the possibility of process contamination, plus makes the distance between process and SemiChem APM 200 less important by virtue of its zero dead-volume.

Note that flow through the SemiChem APM 200's fast flow depends on there being a sufficient pressure drop across it. It may be necessary to adjust or restrict the flow through the main recirculation system accordingly.

3.7 SIGNAL CONNECTIONS

3.7.1 Inputs and Outputs

3.7.1.1 ETHERNET

The SemiChem APM 200 uses a standard $10/100$ Ethernet cable, or category 5 connection. The SemiChem APM 200 has two Ethernet connections. One is for the facility network and the other is for local use with a PC.

3.7.1.2 RS232

The SemiChem APM 200 uses a male RS232 DB-9 connection.

3.7.1.3 USB

For downloading history files and uploading recipes, the SemiChem APM 200 has a standard USB port.

3.7.1.4 ANALOG/PLC HANDSHAKING

The SemiChem APM 200 provides four analog outputs, eight relay contacts, PLC handshaking contacts, and recipe select inputs. Each of the inputs/outputs are connected to the SemiChem APM 200 through a circular plastic connector (CPC). Entegris provides the mating CPC connector and associate pins/sockets. Refer to the wiring diagrams for the exact pin-out for each input and output. The analog outputs are factory configured as 4 – 20 mA outputs, however they can be field configured as 1 – 5 VDC by jumped location. Refer to the wiring diagram for specific information.

3.8 INSTALLATION NOTES

1. Be sure to install energy isolation devices so the SemiChem APM 200 can be isolated from various energy sources such as CDA, DI water, sample lines, and power. The sample isolation valve should be controlled via the SemiChem APM 200's safety interlock fault signal.
2. Pay special attention to the process drain. Be sure the process drain empties into a free flowing drain.
3. DO NOT connect the cabinet drain and the process drain.
4. Only the detachable main supply power cord should be used. If a replacement is used, ensure the rating is adequate.

SECTION 4: UNIT/SYSTEM OPERATION

This section highlights the features and functions of the SemiChem APM 200 software. However, for application specific functions, such as recipes and sensor calibrations, please refer to the appropriate start-up guide located in the appendix. The SemiChem APM 200's operations are controlled through the 6" touchscreen display. This display allows for the operation, calibration, service, and history. The touchscreen Main menus are [SERVICE], [HISTORY], and [HELP]. The [EXPORT] screen is under [History] in the software.

The [MAIN] screen is where the SemiChem APM 200 will remain for most of the time. This screen serves to display the status of the SemiChem APM 200 in terms of latest results, current operation, current analysis curves and signals. This screen also serves as the portal to the other functions for service, history, and help.

The [SERVICE] screen is where the user will find the [LOGIN], [SETTINGS], [RECIPES], [CALIBRATION], and [DIAGNOSTICS]. The SemiChem APM 200 has a password protected login to prevent unauthorized access to the operating parameters. Also, the user will find additional screens for the settings of the application, the recipes with recipe editor, calibration of the sensors, and diagnostic functions for the various system inputs and outputs.

The [HISTORY] screen is where the user can view previous analysis results in a trend, highlight specific data points, and export the history file via the USB port in a .csvs format.

The [HELP] screen is where the user can find electronic versions of the user's guide, start-up procedures, and spare parts information.

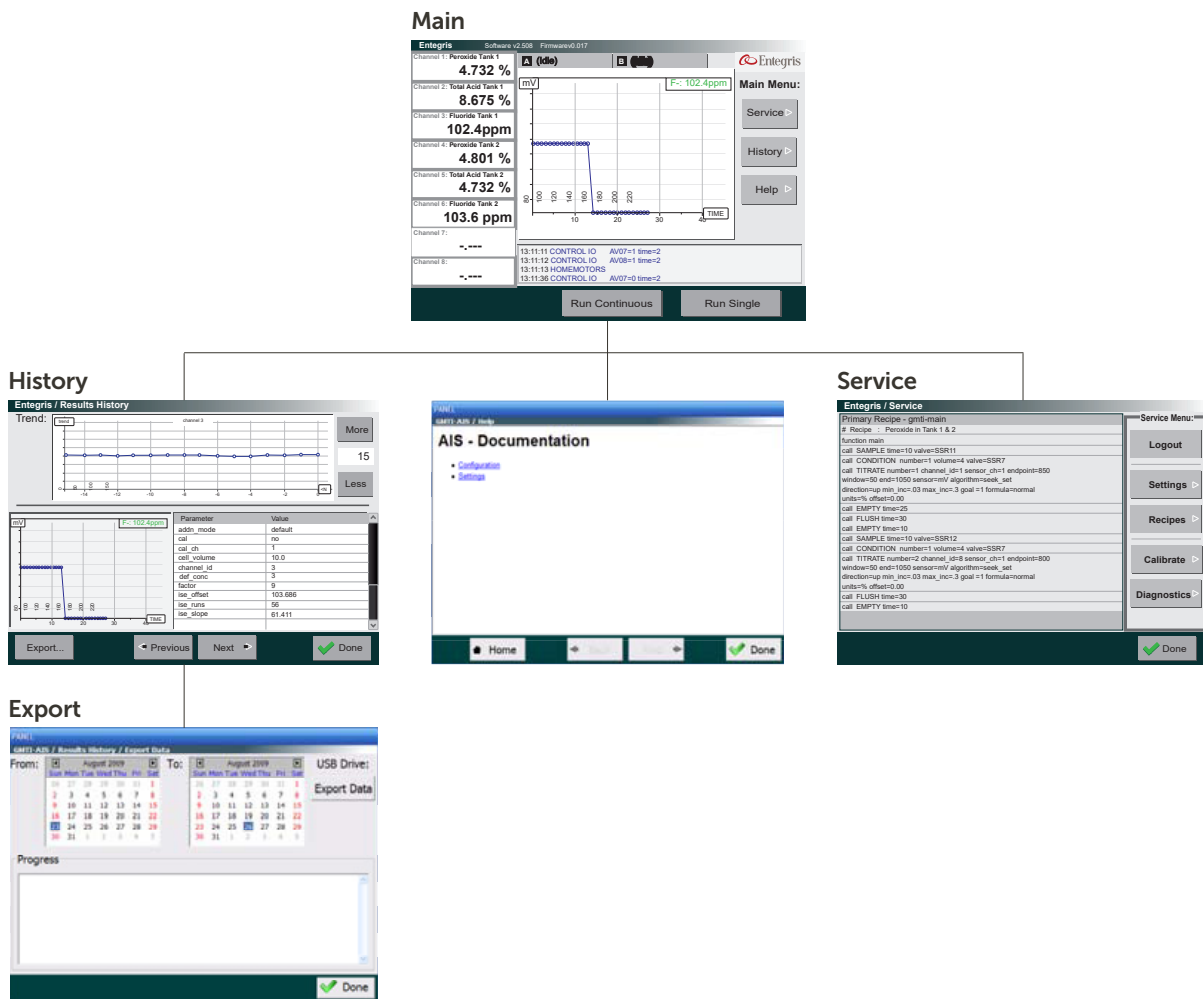

Touchscreen menus.

Login

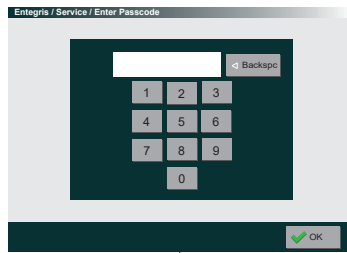

Settings

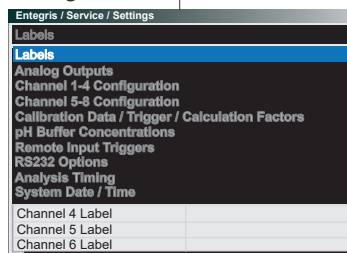

Recipes



Calibration/pH

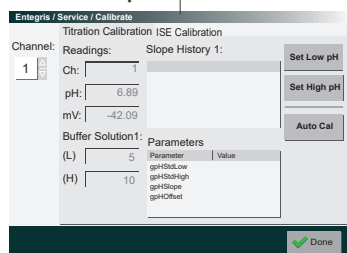

Diagnostics

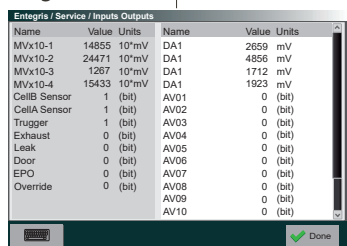

Allows user defined labels

Labels:
Burette #1-4: OPEN
Sample #1-2: OPEN
Outputs #1-8: OPEN

Analog outputs are 1 – 5 VDC.
1 VDC = low end,
5 VDC = high end

Analog Outputs:
Analog Outputs 1-8: ON/OFF
Analog Outputs 1-8: MAX Value

Allows various use of relays
as well as threshold limits

Relay Configuration 1-8:
Channel 1-8 Mode: OFF
Less Than Min
Greater Than Max
Inside Band
Outside Band
Channel 1-8 MIN: User Defined
Channel 1-8 MAX: User Defined

Process: Uses a laboratory
measurement to calculate
the factor.

Factor: A known factor is
used. When used in "process,"
a trusted laboratory value is
entered. Once entered, a
factor is automatically
calculated.

Calibration/Trigger/Calc Factors:
Calibration Type: Process/Factor
Calculation Factors 1-8: User Defined
Analysis Trigger Mode: Local/Remote/
Computer
Sample Dilution: User Defined
Cross Factors (1-2): 1.00

Trigger: local-run independ-
ent, remote controlled from
PLC/Handshaking,
computer- controlled via
RS232. Sample dilution=
Sample Loop/Cell Volume

pH calibration buffers. These
are used for either automatic
or manual calibration

Buffer Solutions:
Buffer Solution 1-8 Low: User Defined
Buffer Solution 1-8 High: User Defined

Used to assign a recipe to a
remote input trigger. Refer
to section 4.2.3 Recipes in
this manual

Remote Input Triggers:
Remote Recipe 0-7: Selected Recipe

Analysis Frequency is used in
local mode only. Equilibration
time is time from reagent
injection to a sensor reading
during a titration

Analysis Timing:
Analysis Frequency: User Defined
Equilibration Time: User Defined

System Date and Time

See pages 17-19 for Commands

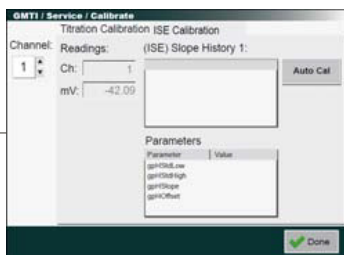

Service screens.

Command	Parameter	Value	Units	Notes	
ABT	---	---	---	Used to end an analysis	
Burette	Number	1 – 4	---	Select which burette	
	Action	Push	---	Downward stroke of piston	
		Pull	---	Upward stroke of piston	
		Home	---	Resets burette in upmost position	
		Set Vol	---	Set volume	
	Volume	Numeric	mL		
	Valve	EV01 – 04		Sets corresponding $\frac{3}{2}$ valve	
Condition	Number	1 – 4	---	Select which burette motor	
	Volume	User	mL		
	Valve	EV01 – 04	---	Sets corresponding $\frac{3}{2}$ valve	
Transfer_Both	time	User	sec	Transfers sample loop to corresponding cell	
Flush_Both	time	User	sec	Flushes both cells	
ContolIO	IO	Stirrer	---	Stirrer when only a single cell	
		Stirrer A	---	Stirrer cell A	
		Stirrer B	---	Stirrer cell B	
		AV01 – 14	---	Air operated valves 1 through 14	
		EV01 – 04	---	Electric valves 1 through 4	
		Pump A	---	Cell A drain pump	
		Pump B	---	Cell B drain pump	
		Relay 3 – 8	---	Contact Relays 3 through 8	
		value	0 or 1	bit	
		time	User	sec	
Empty_Both	time	User	sec	Drains both cells	
AutoCal	Cell	A or B	---	Automatic pH calibration parameter	
	Sensor_ch	1 – 8	---	Sensor input 1 through 8	
	Type	Low/High	---	Selects which point to do first	
	Bur_low	1 – 4	---	Selects burette with low value reagent	
	Volume_low	User	mL	Volume of low reagent	
	Valve_low	1 – 4	---	Corresponding $\frac{3}{2}$ valve	
	Bur_high	1 – 4	---	Selects burette with high value reagent	
	Volume_high	User	mL	Volume of high reagent	
	Valve_high	1 – 4	---	Corresponding $\frac{3}{2}$ valve	
	dwll	User	sec	"Residence time of low and high reagents	

Command	Parameter	Value	Units	Notes
ISE	Cell	A or B	---	Selects cell A or B
	number	1 – 4	---	Selects which burette has standard
	Channel_id	1 – 8	---	Selects which displayed output
	Sensor_id	1 – 4	---	Selects which sensor input
	pH-sensor-id	1 – 4	---	Select which sensor for pH input
	Addn-mode	default	---	2 point calibration
	Meas-Mode	Auto	---	Stops measurement once stable
		fixed	---	Stops measurement at fixed time
	Meas-Time	User	sec	Amount of time for sensor response
	Cell volume	User	mL	Total volume of cell (i.e. 19 – 35 mL)
	Std_conc	User	---	Standard concentration being used
	units	User	---	Displays units on MAIN screen
	Def_conc	User	User	Defines low end of calibration range; refer to start-up procedure
	factor	User	User	Defines high end of calibration range; refer to start-up procedure
	cal	Yes/no	---	Selects if parameters are used for autocal of ISE
	Sample	time	User	sec
valve		AV ^{01/02}	---	Selects sampling valve
Titrate	cell	A or B	---	Selects cell
	Number	1 – 4	---	Selects which burette to use
	Channel_id	1 – 8	---	Selects which displayed output
	Sensor-ch	1 – 4	---	Selects sensor input
	End point	User	pH/mV	Titration end point; see start-up procedure
	window	User	pH/mV	Defines end point window; See start-up procedure
	End	User	pH/mV	Defines titration ending; see start-up procedure
	algorithm	seek	---	Searches for end point within window
		setpoint	---	Assigns end point to set point value
		Seek/set	---	Hybrid; seeking first then resorts to set point
	direction	Up/down	---	Sets direction of titration; also, used for variable reagent volume based on electrode slope
		UP-1/Down-1	---	Sets direction of titration; also, used for variable reagent volume based on volume and expected end point target
	Min inc.	User	mL	Minimum allowed injection volume
	Max inc.	User	mL	Maximum allowed injection volume
	Formula	normal	---	Simple end point calculation
Units	User	---	Labels output	
offset	User	mL	Subtracts set volume of reagent	

Command	Parameter	Value	Units	Notes	
Titrate BG	cell	A or B	---	Selects cell	
	Number	1 – 4	---	Selects which burette to use	
	Channel_id	1 – 8	---	Selects which displayed output	
	Sensor-ch	1 – 4	---	Selects sensor input	
	End point	User	pH/mV	Titration end point; see start-up procedure	
	window	User	pH/mV	Defines end point window; see start-up procedure	
	End	User	pH/mV	Defines titration ending; see start-up procedure	
	algorithm	seek	---	Searches for end point within window	
		setpoint	---	Assigns end point to set point value	
		Seek/set	---	Hybrid; seeking first then resorts to set point	
	direction	Up/down	---	Sets direction of titration; also, used for variable reagent volume based on electrode slope	
		UP-1/Down-1	---	Sets direction of titration; also, used for variable reagent volume based on volume and expected end point target	
	Min inc.	User	mL	Minimum allowed injection volume	
	Max inc.	User	mL	Maximum allowed injection volume	
	Formula	normal	---	Simple end point calculation	
	Units	User	---	Labels output	
	offset	User	mL	Subtracts set volume of reagent	
	WAIT	time	User	sec	
	Transfer A	time	User	sec	Transfer time from 6-port A to cell A
Transfer B	time	User	sec	Transfer time from 6-port B to cell B	
Empty Cell A	time	User	sec	Empty time for cell A	
Empty Cell B	time	User	sec	Empty time for cell B	
Home Motors	Burette 1 – 4	Yes/No	sec	Reset motors	
Flush Cell A	time	User	sec	Time to flush cell A	
Flush Cell B	time	User	sec	Time to flush cell B	
Foto_T100	Sensor_ch	1 – 4	---	Selects which sensor input	
	dwll	User	sec	Amount of time for sensor to stabilize	
Foto_Cal	cell	A or B	---	Selects cell A or B	
	number	1 – 4	---	Selects which burette to use	
	Channel_id	1 – 8	---	Selects which displayed output	
	Sensor_ch	1 – 84	---	Selects which sensor input	
	Std_inc	User	---	Concentration of each calibration step	
	Std_Steps	User	---	Number of calibration points	
	Std_conc	User	---	Standard concentration being used	
dwll	User	---	Amount of time for sensor to stabilize for each calibration point		
Foto_Measure	cell	A or B	---	Selects which cell	
	Channel_id	1 – 8	---	Selects which displayed output	
	Sensor_ch	1 – 4	---	Selects which sensor input	

4.1 MAIN SCREEN

The [MAIN] screen provides the status of the SemiChem APM 200, the latest measurement results, the current analysis curves, and access to further functions.

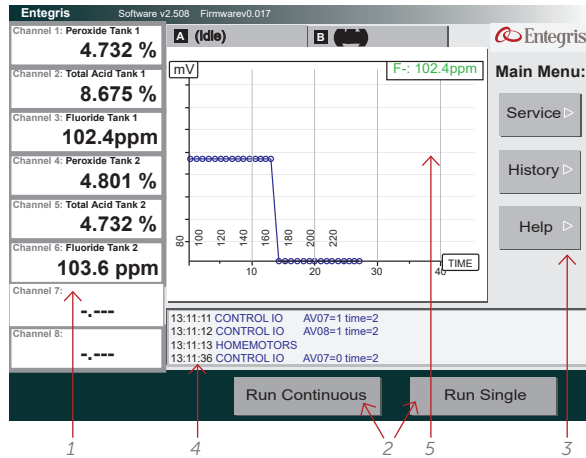

Main screen with callouts.

1. Analysis Results: shows the latest analysis results for up to eight channels. In addition, the channel label and measurement units are shown.
2. Run: choose between running the current recipe a single time or continuously.
3. Menu: allows users to access further features of the SemiChem APM 200.
4. Status: shows the status of the SemiChem APM 200.
5. Sensor display: shows the real-time signal of the SemiChem APM 200 plotted against either time or milliliters of titrant depending on the analysis method.

4.2 SERVICE SCREEN

The [SERVICE] screen allows access to the login, setting, recipes, diagnostics, and calibrations.

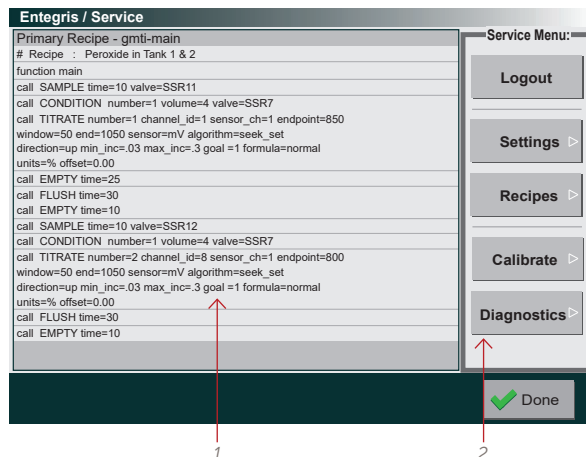

Service screen with callouts.

1. Primary recipe: shows the current recipe being used by the SemiChem APM 200.
2. Service menu: allows access to login, settings, recipes, calibrations, and diagnostics.

4.2.1 Login and Passkey

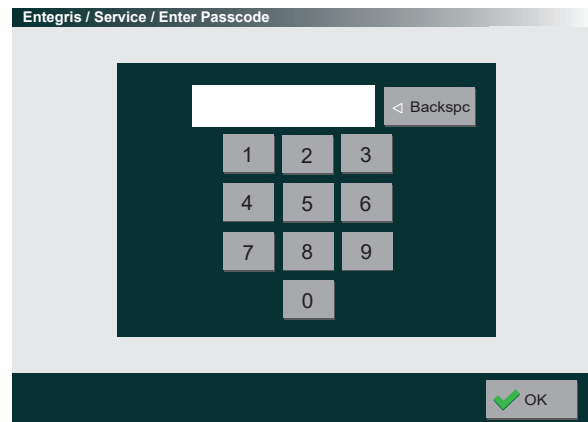

Login access.

The SemiChem APM 200 features a passkey protected login to prevent unauthorized access to the SemiChem APM 200's features. The SemiChem APM 200 supports two passkeys; a maintenance passkey and a process engineering passkey.

Maintenance passkey allows access to the diagnostic screen within the service menu, giving the user the ability to activate the outputs. The maintenance passkey is factory set at "0-0-0-0-0-0".

Process engineer passkey allows access and interaction to all screens. The process engineer passkey is factory set at "1-1-1-1-1-1".

To change the passkeys:

From the [SERVICE] screen, press "Logout". Enter 1-5-9-3-5-7, press "Enter". Press "Start-up", select passkey to be changed. Press the keyboard (bottom left of touchscreen) and enter new passkey. Press "OK" > "OK" > "OK" > "Done". The passkey is now set.

Please note, the SemiChem APM 200 will automatically log out after 60 minutes of inactivity.

4.2.2 Settings

The [SETTINGS] functions are a series of parameters that allow the user to customize the SemiChem APM 200 and integrate it within a larger processing environment. The settings have nine pull down menus:

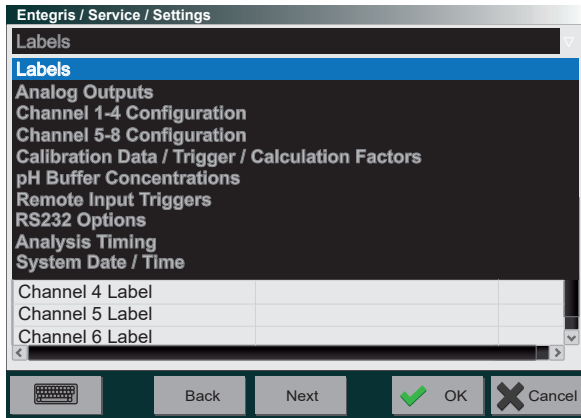

Settings > Pulldown menu.

Within the settings menu, the user will find a pull-down menu for:

Labels: Used to customize the SemiChem APM 200 in terms of reagent names, sample names, and displayed channel names. These are arbitrary and can be named anything the user would like.

Analog Outputs: Used to set the analog output range.

Channel 1-4 and 5-8 Configuration: Programs the alarm relay thresholds. Each relay can be set for: OFF, Less than min, greater than max, inside band, or outside band, and Error.

Calibration/Trigger/Calc Factors: Used to calibrate the SemiChem APM 200 to the process and set up triggering of the SemiChem APM 200 via local mode, remote mode (PLC control), and computer mode (RS232 control).

Remote Input Triggers: Allows user to select which recipe to be trigger by which input.

RS232 Options: Allows user to configure the RS232 data stream and select which relay to be used for general alarm.

System Health: Sets standard deviation factor and PM schedules.

Analysis Timing: Sets frequency, and equilibration times.

4.2.3 Recipes

The SemiChem APM 200 uses recipes to control the analysis functions of the system. These recipes can be newly created from a set of commands or existing recipes can be edited to adjust for individual needs. Prior to shipment, the SemiChem APM 200 is loaded with a variety of recipes to address the more common applications.



Service > Recipes.

Within the [RECIPES], the user can select from the recipe list. Once selected, the user can use the menu to edit the recipe, set as default, or run it immediately.

Each of these recipes can be remotely called upon from either the PLC handshaking or RS232. An individual recipe can be tied to a remote trigger input in SERVICE>SETTINGS> Remote Input Trigger.

Recipes can be used once by pressing "Run Now." Or they can be used in a continuous mode by pressing "Set As Main." This then becomes the SemiChem APM 200's default recipe.

Recipes can also be imported from the USB port.

1. Insert USB drive into SemiChem APM 200.
2. From [MAIN] menu, press "Service," "Recipe," then "Import."
3. A message box will appear, press "OK."
4. Select the recipe to be imported and press "Import File." Once the import is complete the [DONE] button will appear. Press "Done."
5. Remove the USB drive. Import is complete.

4.2.4 Calibration

For the SemiChem APM 200 to perform precise and accurate measurements, the sensors must be calibrated on occasion. Depending on the application, the sensors may be calibrated automatically or manually.

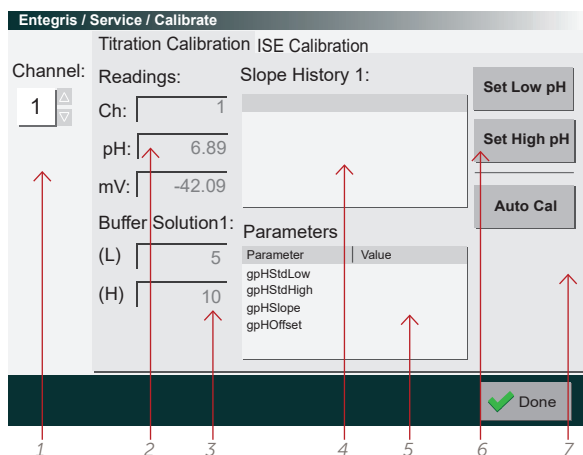

Service > Calibrate> pH electrode.

1. Selects which electrode input channel to be calibrated.
2. Current electrode readings.
3. Buffer solutions being used for that channel. These are setup in the [SETTINGS].
4. Slope history of previous calibrations.
5. Current calibration values.
6. Use set low pH and set high pH when manually calibrating the pH electrode.
7. Auto Cal is a feature that can be used if two reagents have known, separate, and stable pH values. The pH electrode can be calibrated in an automatic sequence. This automatic sequence can be initiated by this calibration screen, or it may be called upon by the recipe selection option. The auto calibration function is driven by an associated recipe. For more details, refer to the Application Guide.

4.2.5 Diagnostics

The [DIAGNOSTICS] function allows the users to monitor the inputs of the SemiChem APM 200 and manually trigger the outputs.

Entegris / Service / Inputs Outputs					
Name	Value	Units	Name	Value	Units
MVx10-1	14855	10*mV	DA1	2659	mV
MVx10-2	24471	10*mV	DA1	4856	mV
MVx10-3	1267	10*mV	DA1	1712	mV
MVx10-4	15433	10*mV	DA1	1923	mV
CellB Sensor	1	(bit)	AV01	0	(bit)
CellA Sensor	1	(bit)	AV02	0	(bit)
Trigger	1	(bit)	AV03	0	(bit)
Exhaust	0	(bit)	AV04	0	(bit)
Leak	0	(bit)	AV05	0	(bit)
Door	0	(bit)	AV06	0	(bit)
EPO	0	(bit)	AV07	0	(bit)
Override	0	(bit)	AV08	0	(bit)
			AV09	0	(bit)
			AV10	0	(bit)

Service > Diagnostics.

In the [DIAGNOSTICS] screen, the left window has the internal inputs for the SemiChem APM 200. The right window has the system outputs. The user can use the diagnostic function to troubleshoot either inputs or outputs.

Inputs identified as mV \times 10 – 1 (through-4) are the electrode inputs. Note, the SemiChem APM 200's electrode inputs are -2500 mV to +2500 mV.

Outputs identified as DA1 (through 4) are the analog outputs. Note, the SemiChem APM 200's analog outputs are 1 – 5 VDC.

To activate any of the outputs, simply touch the output. The output will activate and the zero will change to a 1.

The SemiChem APM 200's flexibility and recipe driven function offers almost unlimited configurations. To help the user navigate the software the following resources are available:

1. Software flow chart on pages 15-16 of this manual. This identifies all the various input variables in the software.
2. Application specific guides and manuals offer step-by-step guidance in using the SemiChem APM 200. Within the APM 200, the most common recipes are available. The guides and manuals do not hold recipes, the AMP 200 stores the default/common recipes.

4.3 ERRORS AND ANALYSIS TROUBLESHOOTING

This section is designed to help the user understand errors and their possible causes using the analysis curves.

Table 4.1 Error codes

ERROR CODE	DESCRIPTION	POSSIBLE CAUSE
Door	Door safety interlock violation.	Door to the wet module is open.
Leak	Leak detector violation.	Possible leak or spill in the wet module.
EPO (Emergency Power Off)	EPO switch is activated.	EPO switch is activated.
Override Activated	Interlocks bypassed.	Interlock key switch is activated.
E1 Sample Neutral	Measuring cell A sample is already neutral.	Initial sensor reading is already above/below programmed end point. Sample may not have transferred. The cell may not have drained or flushed properly.
E2 Sample Neutral	Measuring cell B sample is already neutral.	Initial sensor reading is already above/below programmed end point. Sample may not have transferred. The cell may not have drained or flushed properly.
E8 Cell A	Too many data points; more than 200 reagent injections.	Reagent not injecting properly into the measuring cell. Possible faulty reagent concentration.
E8 Cell B	Too many data points; more than 200 reagent injections.	Reagent not injecting properly into the measuring cell. Possible faulty reagent concentration.
E64 Cell A	Measuring cell level sensor time out.	Transfer water may not be working properly.
E64 Cell B	Measuring cell level sensor time out.	Transfer water may not be working properly.
Reagent #1 (through #4) low	Reagent less than 10% volume.	Reagent low level sensor activated. Refill reagent bottle(s).

4.4 ANALYSIS CURVES FOR TROUBLESHOOTING

The real time analysis curves can act as a “fingerprint” for the particular application. Interpretation of error codes should be done in conjunction with evaluation of analysis curves. This section will discuss interpretation of analysis curves and the possible causes of a measurement failure.

Each application will have a specific analysis curve. The analysis curve is generated by the sensor response (in mV or pH) plotted against either time or volume. The analysis curves are particularly useful because it is a true indicator of the events in the measuring cell. By understanding what the system “should” be doing and what the system is actually doing will allow a user to quickly pinpoint the error source.

4.4.1 Titration Analysis

Although many different titrations can be used, they all have some features in common. First, the analysis curve is plotted as sensor response (y-axis), which can have positive or negative numbers, against volume of reagent added (x-axis). In doing so, the analysis curve is almost always an S-shaped curve. Each application will have different initial mV readings, varying slope of the curve, and varying end points. But within a particular application, the analysis curve will always behave consistently. From this aspect, it is important to note what a typical analysis curve will look like for the user’s application.

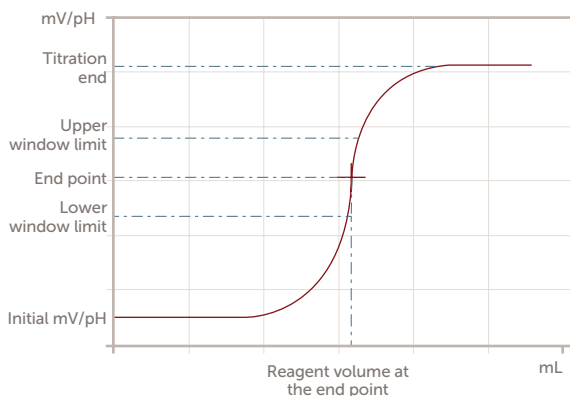

Typical titration curve.

Noted on the curve are the key features of the typical titration analysis curve. First, several of analysis curve features are programmable parameters that are input by the user. The titration end, the window limits, and the end point are all required variables to be programmed. See your application’s corresponding start-up procedure for proper set-up parameters. Second, the curve shows the initial millivolt value. Although not programmed, this value is especially useful in determining the cause of errors. Finally, the reagent volume at the end point is used in the calculation of the systems final result.

Once the user understands the correct analysis curve, it can be compared to the following examples.

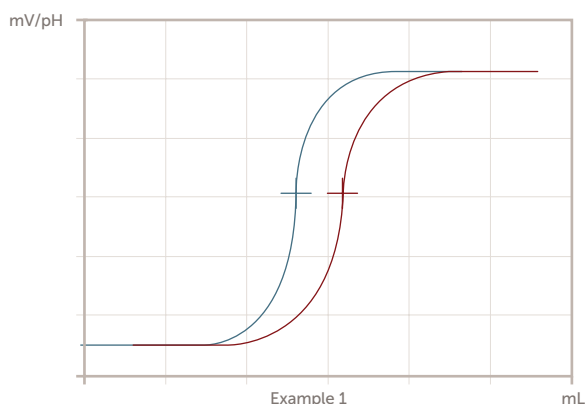

Example 1 shows a curve shifted to the left (in blue). This would be shown as a lower than expected result. The possible causes are, 1. the process itself has a lower concentration and the SemiChem APM 200 reports the correct result, 2. possible air bubble in the sample causing a lower than expected value, 3. a stronger titrant it being used resulting in less being required to reach the end point. Note the initial mV and titration end are the same. This indicates the chemistry is working.

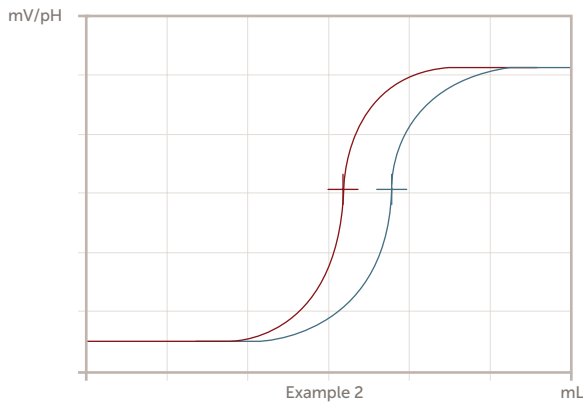

Example 2 shows a curve shifted to the right (in blue). This would be shown as a higher than expected result. The possible causes are, 1. the process itself has a higher concentration and the SemiChem APM 200 reports the correct result, 2. possible air bubbles in the reagent line causing more reagent to be used than expected, 3. a weaker titrant being used resulting in more volume required to reach the end point. Note the initial mV and titration end values are the same, this indicates that the chemistry is working.

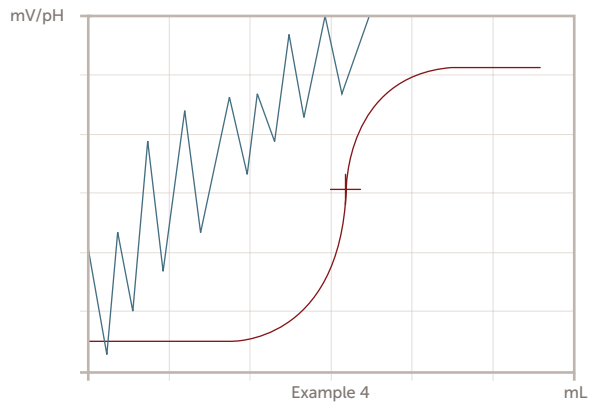

Example 4 shows a noisy signal from the sensor. Possible causes are, 1. malfunctioning electronics, 2. disconnected sensor, 3. incorrect sensor, 4. electrode not immersed in the sample, 5. low electrolyte in the sensor.

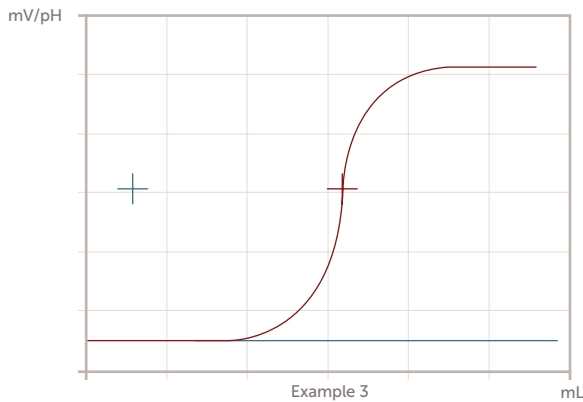

Example 3 shows a flat line indicating no response from sensor. The possible causes are, 1. no reagent, 2. a very weak reagent, 3. the wrong reagent, 4. a very strong sample, 5. malfunctioning reagent dispenser. This scenario would most likely be accompanied with an error code 8. Since the initial millivolts are consistent, most likely the sensor and associated electronics are performing properly.

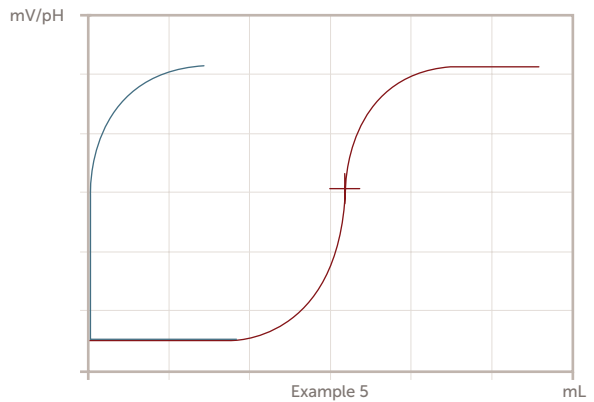

Example 5 shows an immediate change in sensor response. The possible causes are, 1. no sample, 2. very strong reagent, 3. very weak sample.

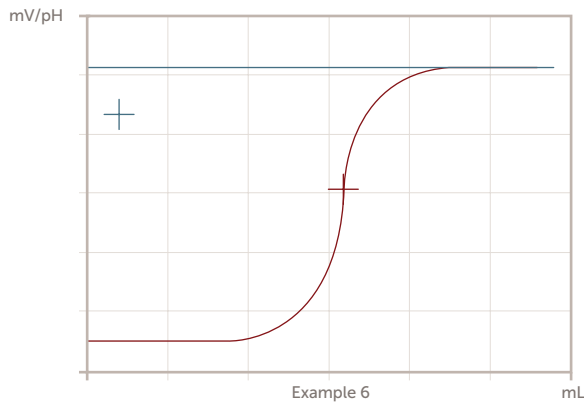

Example 6 shows a sensor response above the programmed end point. The user would not see this because the SemiChem APM 200 will abort the analysis and report an error code 1 or 2. A possible cause is the cell did not drain and flush properly.

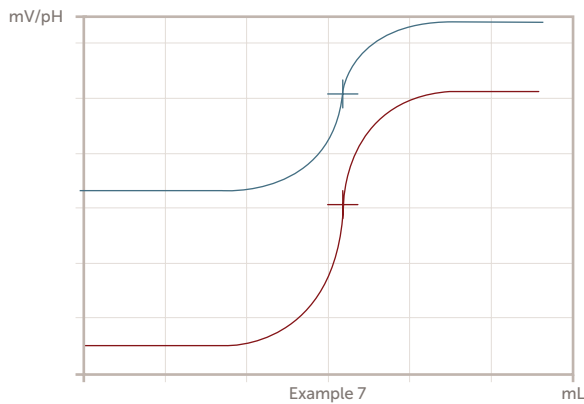

Example 7 shows a sensor response that is above the expected mV range. Possible causes are, 1. incorrect set-up parameters, 2. incorrect sensor calibration, 3. electrode drift outside of the end point window.

4.4.2 Standard Addition Analysis (ISE's)

Similar to the SemiChem APM 200's titration analysis method, the system's standard addition method also displays the sensor's response in real time giving valuable troubleshooting information. The standard addition analysis curves differ from titration curves in that rather than plotted mV to volume of reagent, they are plotted sensor response (y-axis) to time (x-axis).

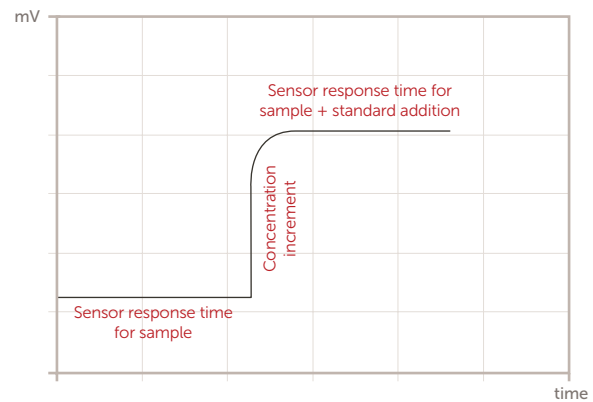

Typical standard addition curve.

On a standard addition analysis curve, the initial portion of time, "Sensor response time for sample", is the sensor response of the sample and any added buffers. The sensor will continue this reading for the programmed amount of time. The change in millivolt signal, "Concentration increment", is the added standard causing the sensor response to change. The later portion of time, "Sensor response time for sample + standard addition", is the sensor response after the standard addition. The volume of added standard is calculated by the SemiChem APM 200 based on the calibration range of the analysis.

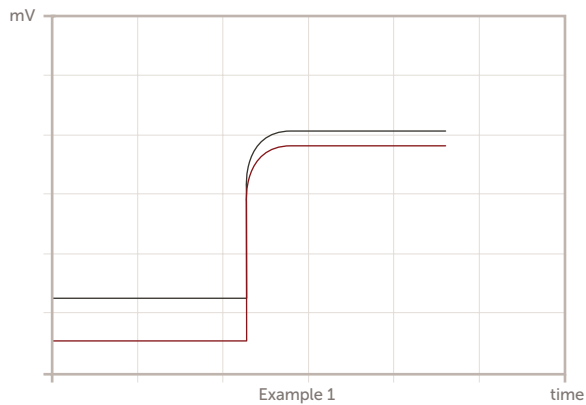

Example 1 shows initial sensor response is lower than expected. Possible causes are, 1. weaker sample concentration, 2. no sample, 3. weak or no buffering agent.

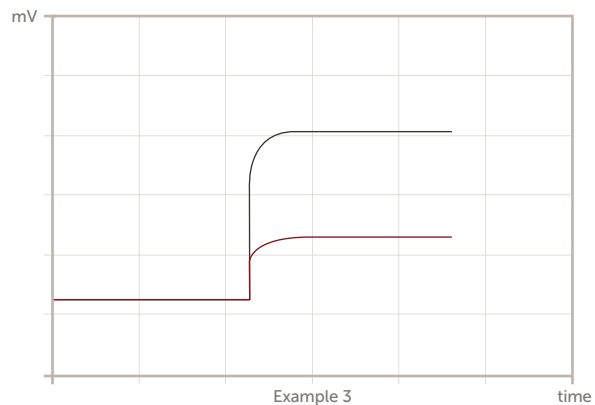

Example 3 shows a lower than expected sensor response after the standard addition. Possible causes are, 1. weak or no standard, 2. low sensor response slope. Because the initial millivolts are consistent it is likely the sensor and associated electronics are functioning properly.



Example 2 shows no change in sensor response after the initial measurement. Possible causes are, 1. very weak or no standard, 2. standard dispensing malfunction. Because the initial millivolts are consistent it is likely the sensor and associated electronics are functioning properly.

In each case, either a titration or standard addition method, the sensor response is a key feature when troubleshooting the system. Detailed analysis curve data can be exported via the USB port for off-board diagnosis. The ability to understand what the analysis data should look like is important in diagnosing the SemiChem APM 200's performance and if necessary can help guide troubleshooting.

4.5 HARDWARE TROUBLESHOOTING

The following section provides detailed troubleshooting for the most common hardware/electrical scenarios. These simple procedures can be accomplished in little time and therefore can save valuable downtime.

These procedures may be illustrated by graphics that show the steps from the very end of an I/O back to its source in the electronics module. However, the graphics are not intended to replace the wiring diagrams, but rather supplement them. These troubleshooting steps have been designed with fully trained, qualified, and experienced personnel in mind. Working with the SemiChem APM 200 at the level these procedures require may lead to exposure to chemical, electrical, or mechanical hazards.

⚠ WARNING: Service of the SemiChem APM 200 may cause exposure to hazardous conditions including chemical, electrical, and mechanical dangers. Personnel should be properly trained in all areas before attempting to service or troubleshoot the analyzer.



⚠ WARNING: Electrical Precaution: High voltage electronics (110/220 VAC) are located throughout the electronics module. Printed circuit boards are powered with 24 VDC. All service should be performed by a qualified electrician/ electrical technician.



⚠ WARNING: Chemical Precaution: Corrosive or poisonous liquids. Some reagents may be corrosive to the eyes, skin, and respiratory tract and may be hazardous if ingested. Wear chemical resistant gloves, face shield, and apron when changing the burette O-ring. See MSDS for further health hazard information. To minimize chemical exposure, purge the burette with air by removing the reagent intake line from the reagent bottle, then flush the appropriate burette. This will remove most of the reagent from the burette assembly. If replacing the burette glass, consult with on-site environmental personnel for proper disposal of remaining reagents. If replacing a burette O-ring, keep the burette glass assembly within the enclosure for proper exhaust of fumes.



⚠ WARNING: Mechanical Precaution: pressurized sample, reagent, air, and water lines all present dangerous conditions. Be sure to properly depressurize all lines prior to servicing the SemiChem APM 200.



⚠ WARNING: Always disconnect the main power line prior to any service to the SemiChem APM 200.



The following is a brief description of the electrical systems within the SemiChem APM 200.

Power: Main power enters the SemiChem APM 200 via fused system power switch. Power is immediately dropped by the linear power supply to 24 VDC. The low power, 24 VDC, feeds the MAIN PCB and the touchscreen. The MAIN PCB sends 24 VDC to the EPO PCB. If all interlocks are satisfied, the EPO returns 24 VDC to the MAIN PCB as well as the MOTOR, REAGENT, and EXPANSION PCBs.

SemiChem APM 200 Network: The SemiChem APM 200 utilizes an internal Ethernet network. This network allows communication between the touchscreen, the MAIN, MOTOR, EXPANSION, EPO, REAGENT, Ethernet Switch, and the end user's Ethernet. Each of the PCBs feature a series of mini-LEDs which represent power and communication.

MAIN PCB: This circuit board is used for processing internal and external I/Os. Internal I/Os are cell level sensor inputs and electrode sensor inputs. Internal outputs are solenoid valves and electrical valves. External inputs are customer PLC handshaking triggers. External outputs are customer relays and analog outputs.

MOTOR PCB: This circuit board is used to drive the four burette motors.

EPO PCB: This circuit board is used to control power to all other boards. It will not allow power if any of the interlocks are violated, thus preventing the operation of the SemiChem APM 200. Inputs to this board include the door, EPO, leak, and exhaust interlocks. These interlocks can be bypassed by a maintenance key. If an interlock is violated, it must be restored to resume operation. In addition, the interlock reset button must be pushed and released.

EXPANSION PCB: This circuit board is an expansion I/O to accommodate more outputs than the MAIN could accommodate.

REAGENT PCB: This board is used for reagent levels. Its inputs are up to four liquid level sensors in the reagent module.

4.5.1 System Shutdown and Decon Procedures

Prior to any work on the SemiChem APM 200, the system should be properly shut down and all energies to be isolated and depressurized.

Prior to powering down the SemiChem APM 200, the following steps should be taken to ensure all stored energies are released and the SemiChem APM 200 is decontaminated from process chemicals and reagents.

To flush the system from process chemicals:

1. The SemiChem APM 200 has no built in provisions to fully flush sample valve AV01 (or AV02 if equipped).
2. Entegris recommends using the drawing, "Install Concepts" as a guide to install the SemiChem APM 200 with provisions to fully flush the SemiChem APM 200's sampling valves. If the customer provides a DI water flush valve as part of the installation, the flush valve can be used in conjunction with the SemiChem APM 200's "Decon" Recipe.
3. The end user opens the DI water flush valve (indicated as AV05 per Install Concepts Drawing. While the DI water valve is open, the end user selects "Decon" from the recipe list. This will allow DI water to rinse all the SemiChem APM 200's sampling fluidics with DI water. Allow water to flow for several minutes (five – 10 minutes) to ensure a complete removal of all process chemicals from within the SemiChem APM 200.
4. The end user closes the DI water valve. If the end user's installation included a CDA purge valve, it can be used in the same manner to purge the DI water from the system.
5. Once complete, the SemiChem APM 200's sampling system is free of process chemicals.
6. Using the Recipes, select "Drain Rinse" recipe. This recipe will spray the cell for several minutes (four minutes) to flush both the cell and the drain sump with DI water removing all process chemicals.

To flush the system from reagents:

The end user will need a 1 liter (1000 mL) large mouth plastic bottle filled with approximately 500 mL of DI water.

1. Remove each reagent line from the reagent bottles.
2. From the [MAIN] screen, press "Stop Continuous" and "Service."
3. From the [SERVICE] screen, press "Recipes."
4. Scroll through the list of recipes and select "Refill Burette #X" and select whichever burette is desired.

5. Press "Run Now." The selected burette will cycle up and down three times. For each burette, the burette glass will be about 50% full. Remove the burette glass and discard the remaining reagent in a suitable waste collection. Rinse each glass with DI water. Replace the glass onto each piston.
6. Place each reagent tube (with tubeweight) into the 1 liter bottle of DI water.
7. Repeat steps 2 – 5 for each burette.
8. Each burette should now be full of DI water. Remove the reagent tubes from the 1 liter bottle of DI water.
9. Repeat steps 2 – 5 for each burette.
10. From the [SERVICE] screen, Press "Recipes."
11. Scroll through the list of recipes and select "Flush Cell," and press "Run Now."

Once complete, each burette system should be rinsed with DI water and purged with air and free of any remaining reagents.

Once the above procedures are complete, the SemiChem APM 200 will be free of process and reagent chemicals. The SemiChem APM 200 can be safely powered down by using the power switch at the power switch module.

When CDA is isolated from the SemiChem APM 200, the internal regulator releases stored energy.

4.5.2 Electrical Module Troubleshooting

4.5.2.1 ELECTRICAL SYSTEM VISUAL INDICATORS

The SemiChem APM 200 has a variety of visual indicators in the electrical module. The power supply has a green "DC OK" LED, and each printed circuit board has a variety of LEDs indicating communications and power. If the user verifies the LEDs, then the circuit boards have power and are communicating within themselves as well as the internal network.

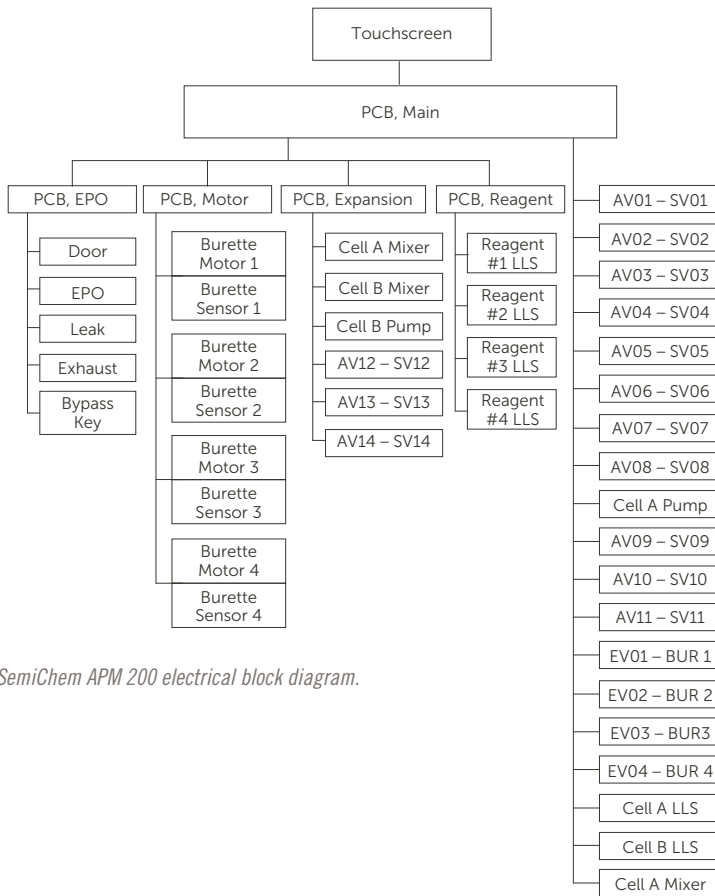

SemiChem APM 200 electrical block diagram.

SYMPTOM	POSSIBLE CAUSE	CHECK AND CORRECTIVE ACTION
No power at start-up	<ul style="list-style-type: none"> Analyzer not connected to power source. Defective power line. Voltage selector not properly set. Damaged power supply unit. Low voltage (i.e., 80 VAC). 	<ul style="list-style-type: none"> Check that the analyzer is plugged into the power source and the power cord is securely inserted into the power switch. Check for visual indicators such as interlock reset switch glowing green, touchscreen powered on, mini LEDs on each of the printed circuit boards. Unplug the analyzer and check the system fuses: <ul style="list-style-type: none"> Unplug power cord. Using a small flathead screw driver, open the power switch cover. Using a small flathead screw driver, remove the fuse holder. Remove both fuses and visually inspect for a blown fuse. Alternatively, using a multimeter, check continuity of the fuses. Replace fuses, fuse holder, and reinstall power cord. Verify the power supply input selector switch is set correctly. Verify the "DC OK" green LED is illuminated on the power supply. Using a DC voltmeter, verify 24 VDC output.

4.5.3 Burette System Troubleshooting

4.5.3.1 POTENTIAL SYMPTOMS

1. Piston not moving.
2. Piston moving, but reagent is not being dispensed.
3. Piston moving, but burette glass is not filled.
4. Irregular or shuddering piston movement.

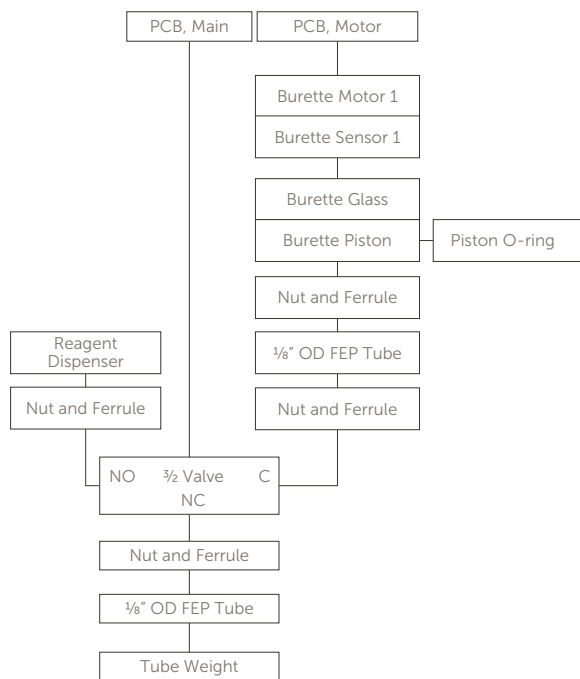

Burette system block diagram.

4.5.3.2 BURETTE ASSEMBLY

The components of the burette system are:

1. MOTOR PCB
2. Stepper motor and stepper motor photo sensor
3. Piston/Driver/Piston O-ring
4. Burette glass
5. 3/2 Burette valve
6. Tube set
7. Guideposts and mounting screws

4.5.3.3 BURETTE OPERATIONAL TEST

The following steps are used to test the burette's operation.

1. From the [MAIN] screen, press "Stop Continuous" and "Service."
2. From the [SERVICE] screen, press "Recipes."
3. Scroll through the list of recipes and select "Refill Burette #X" and select whichever burette is desired.
4. Press "Run Now."

The selected burette will cycle up and down three times. On the downward stroke, the burette will push the contents of the burette glass into the measuring cell. On the upwards stroke, the burette will pull the content of the reagent bottle.

To be successful, the burette should move up and down smoothly the entire stroke.

4.5.3.4 BURETTE VISUAL INDICATORS

The burette system has a variety of visual indicators. Each burette system has a photometric sensor with a red LED indicating power. Each of the mini 3/2 electric valves have a red LED when activated. The MOTOR PCB has flashing LEDs indicating power and communications.

SYMPTOM	POSSIBLE CAUSE	CHECK AND CORRECTIVE ACTION
Piston moves irregularly, shudders, or does not move the full distance.	<ul style="list-style-type: none"> Misaligned guideposts. Deformed, swollen, worn piston O-ring. Driver shaft damage. 	<ul style="list-style-type: none"> Take all necessary precautions. Using a $\frac{1}{64}$" ball driver, remove the two screws and remove the burette glass. Perform the operational test as outlined above. Be sure the guideposts are securely attached to their mounting plate. If the piston moves freely, replace O-ring as outlined in Section 7.2, Replacing the Burette O-rings. Replace glass, if problem persists, replace the burette glass. If the problem persists, contact Entegris.
Burette does not fill with reagent.	<ul style="list-style-type: none"> Reagent bottle is empty. Tube is out of reagent bottle. Tube is suspended above the reagent. $\frac{3}{2}$ valve is damaged. Tube is crimped. Piston O-ring deformed or worn. Nut and ferrule combination deformed. Reagent too viscous. 	<ul style="list-style-type: none"> Note: Highly concentrated reagents may be too viscous. Dilute reagent with DI water. Check the reagent bottle, fill if necessary. Verify the tube weight is installed and the reagent line rests on the bottom of the bottle. Perform the operational test; if the $\frac{3}{2}$ valve does not activate proceed to the $\frac{3}{2}$ valve section. If the problem persists inspect tubing for damage/plug. Replace if necessary. Replace piston O-ring and repeat operation test. If the problem persists, remove tubing from the $\frac{3}{2}$ valve and burette piston and inspect the nut/ferrule combination. Overtightening will deform the ferrule and prevent an airtight seal. If problem persists, contact Entegris.
Piston does not move.	<ul style="list-style-type: none"> Misaligned guideposts. Deformed, swollen, or worn piston O-ring. Distorted burette glass. Damaged drive screw. Electronics problem. 	<ul style="list-style-type: none"> Take all necessary precautions. Using a $\frac{1}{64}$" ball driver, remove the two screws and remove the burette glass. Perform the operational test as outlined above. Be sure the guideposts are securely attached to their mounting plate. If the piston moves freely, replace O-ring as outlined in Section 7.2, Replacing the Burette O-rings. Replace glass, if problem persists, replace the burette glass. Within the electronic areas, and referring to the wiring guides, swap the faulty motor/sensor connector to a known good connection. Perform the operational test. If the problem persists, replace the burette motor. If the problem persists, contact Entegris.
Burette not dispensing reagent into the measuring cell.	<ul style="list-style-type: none"> Deformed, swollen, or worn piston O-ring. Nut/Ferrule combination deformed. $\frac{3}{2}$ valve is not operating. Reagent dispensing tip blocked. 	<ul style="list-style-type: none"> Check that the burette and reagent bottle is filled with reagent. Otherwise refer to the "Burette not filling with reagent" section. Perform the operational test; if the burette $\frac{3}{2}$ valve does not activate refer to the $\frac{3}{2}$ valve check procedure section. Remove the reagent dispenser from the measuring cell and place in a suitable container such as a small bottle or beaker. Repeat the operational test. If the reagent flows properly, reinsert the dispenser into the measuring cell. If the problem persists, disconnect the tubing from the $\frac{3}{2}$ valve common port and place in a beaker. Perform operational test. If reagent flows properly, inspect the $\frac{3}{2}$ valve for damage or plugging. Replace valve if necessary. If problem persists, remove tubing from piston and $\frac{3}{2}$ valve and inspect the nut/ferrule combination. If deformed or damaged, replace tubing. Note: nut should only be finger tight. If problem persists, contact Entegris.

SYMPTOM	POSSIBLE CAUSE	CHECK AND CORRECTIVE ACTION
Bubbles in burette.	<ul style="list-style-type: none"> Degassing of reagents. Tube end suspended over reagent level in bottle. Leak. Damaged reagent tubing. Nut/Ferrule combination too loose or too tight. 	<ul style="list-style-type: none"> Check the reagent bottle for evidence of reagent degassing. For example, gas bubbles collecting on the sidewalls of the reagent bottle. If present, contact Entegris for advice on suitable reagents. Check the tube (with tube weight) is properly placed in the reagent container. If bubbles are small and only in the burette glass, it may indicate a new glass assembly. These bubbles will disappear after some use. Check the nut/ferrule combination for either too tight or too loose. Do not overtighten as it will deform the ferrule and cause leaks. If problem persists, contact Entegris.
Reagent going back into the reagent bottle.	<ul style="list-style-type: none"> Nut/ferrule combination may be damaged. $\frac{3}{2}$ valve may not be functioning. 	<ul style="list-style-type: none"> Check the nut/ferrule combination for either too tight or too loose. If overtightened, it will deform the ferrule and cause leaks. Perform operational test. Visually verify the $\frac{3}{2}$ valve red LED light when the valve is activated. If shown, the valve has power. Refer to nonfunctioning $\frac{3}{2}$ valve section. If problem persists, contact Entegris.
Nonfunctioning $\frac{3}{2}$ valve – To be performed after all other causes ruled out.	<ul style="list-style-type: none"> Loose connection. Burned out valve. Faulty circuit board. 	<ul style="list-style-type: none"> Perform an operational test. When the burette piston pulls up, verify the red LED indicator light illuminates on the $\frac{3}{2}$ valve. If LED indicator light does not illuminate, visually verify the either the MAIN PCB or EXPANSION PCB has communication and power. If power and communication, remove the cable from the suspect valve and replace with the cable of a known good valve. From the [SERVICE] > [DIAGNOSTICS] screen, activate the known good output. Verify the red LED light. If illuminated, contact Entegris.
Nonfunctioning stepper motor.	<ul style="list-style-type: none"> No power. No communication. Faulty motor. 	<ul style="list-style-type: none"> Visually inspect burette motor photo sensor for red LED indicator light. If present, burette has power. If red LED is not present, visually inspect other burette photo sensors. If not present, visually inspect MOTOR PCB for communication and power. If red LED is present, remove suspected motor connection from MOTOR PCB and reposition to a known good motor position. Perform operational test, be sure to select burette flush command for known good motor. If motor moves properly, contact Entegris. If motor does not move properly, replace stepper motor.

4.5.4 Sensor Troubleshooting

Proper sensor maintenance is critical to maintain the SemiChem APM 200's high reliability and performance. It is important that sensors are calibrated as part of a normal maintenance routine. Also, it is important for the sensors and the measuring cell to remain clean, contact Entegris for advice on compatible cleaning solutions.

Depending on the application, the SemiChem APM 200 may have up to four sensors. The sensing system comprises the sensor and the sensor cable. The sensor cable plugs directly into the MAIN PCB. The sensor, sensor cable, and the MAIN PCB make the sensor circuit. Each sensor is required to have two parts, the sensing element and the reference element. As shown by the picture to the right, the sensing circuit is the reference electrode, the sensing electrode, a voltmeter (in this case the SemiChem APM 200), and the sample to be measured. Without any of these components, the sensing circuit will show an open circuit.

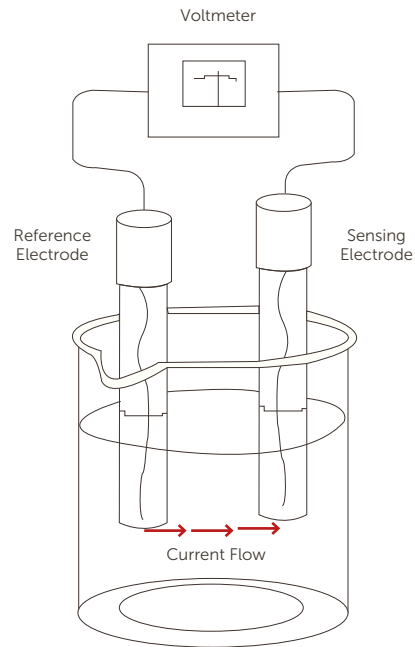

SYMPTOM	POSSIBLE CAUSE	CHECK AND CORRECTIVE ACTION
Unstable or erratic sensing signal. Nonresponsive electrode. Shift in the mV signal or no signal at all. Signal locked at maximum or minimum value.	<ul style="list-style-type: none"> • Bad electrode. • Bad electrode cable. • Faulty electronics. 	<ul style="list-style-type: none"> • Calibrate the suspect electrode. Verify proper slope of the electrode. • From the [MAIN] screen, press "Service." "Diagnostics." • Remove the electrode from the cable. Using a small wire, touch the outer portion of the connector and the inner portion of the connector. Verify the mV go to near zero on the [DIAGNOSTICS] screen from the suspected input. If so, there is continuity throughout the sensing circuit (less the electrode). • Using a mV simulator (contact Entegris for more details on a proper simulator), connect the simulator directly to the suspected input on the MAIN board. Vary the mV simulator at different points between +2500 and -2500 mV. Verify the SemiChem APM 200 tracks the same reading. If so, the electronics are performing correctly. • Replace the electrode. • If problem persists, contact Entegris.

SECTION 5: OPTIONS

The SemiChem APM 200 has a variety of ways to use the measurement data. The data is stored internally and can be accessed through the systems [HISTORY] function, the data can be exported via the USB drive, and finally the data is sent from the SemiChem APM 200 through the analog outputs, a RS232, and its Ethernet port.

5.1 HISTORY

The SemiChem APM 200 features a history function which can be viewed from the [HISTORY] button from the [MAIN] screen.

As shown in figure 4.1, the [HISTORY] screen shows a trend line, the analysis curve of the selected data point, and the analysis data pertaining to the data point. As an added feature, the displayed history can be exported via the USB drive directly to a flash memory device.

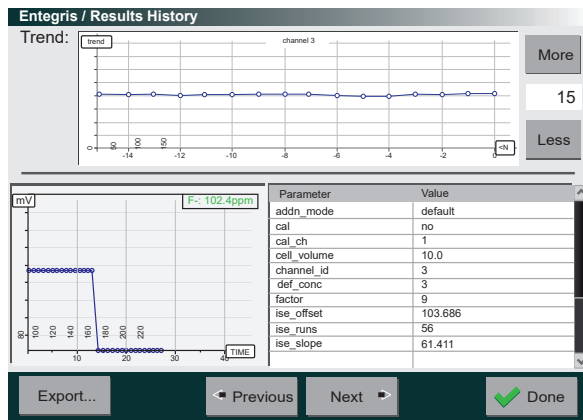

History

The upper window shows the trend for the selected channel. The low left shows the selected data point's analysis curve. Refer to section 4, Unit/System Operation for advice on using this curve to help diagnose results. The lower right is the data used for the selected result.

The data can be exported via the USB port. Simply insert a USB flash drive into the SemiChem APM 200's USB drive. In addition to analysis data, the SemiChem APM 200 can also export the systems logs. These are useful when troubleshooting suspect results.

Press "Export," choose the date range you wish to export. The user can select to export either the analysis data or the system logs for the date range. The lower window is the export status window. Analysis data is exported as a .csv file; whereas the systems logs are exported as a .log file that can be opened in any text application.

	A	B	C	D	E
1	mL	mV	pH	key	value
2	0	568.1	-3.62	ML	0.604
3	0	563.2	-3.536	MV	1142.5
4	0.01	564.4	-3.556	MVx10	11425
5	0.02	565.8	-3.581	PH	-13.575
6	0.03	566.7	-3.596	_originx	0
7	0.04	567.1	-3.603	_originy	563.2
8	0.05	568.3	-3.624	_sizex	1
9	0.06	568.3	-3.624	_sizey	1000
10	0.07	569.3	-3.641	_timestamp_id	0x5faab939
11	0.079	570.8	-3.667	alg	seek_set
12	0.089	572.3	-3.693	analysis_start	2020-11-10T16:00:57
13	0.099	572.2	-3.692	badslp	0
14	0.109	572.5	-3.697	cell	A
15	0.119	575.4	-3.747	channel_id	1
16	0.129	575.7	-3.752	dir	up_1
17	0.139	576.9	-3.773	end	1140
18	0.148	577.4	-3.782	endpoint	800
19	0.158	579.2	-3.813	equib	8
20	0.167	580.4	-3.834	filename	20201110_160057_A.csv
21	0.177	580.7	-3.839	first_mv	568.1
22	0.186	582.6	-3.872	first_ph	-3.62
23	0.196	583.9	-3.894	formula	normal
24	0.205	584.6	-3.906	gPhOffset	6.23
25	0.214	587	-3.948	gPhSlope	-57.7
26	0.223	587.2	-3.951	goal	0
27	0.233	589.9	-3.998	max_inc	0.01
28	0.242	591.2	-4.021	min_inc	0.005

In the history output file, column A is the milliliters of titrant or time depending on analysis method, column B is the sensor response in millivolts, column C is the sensor response in pH (if applicable), column D is analysis parameter, and column E is the value of the analysis parameter.

The history files and system logs can be emailed to Entegris for remote diagnostics as well as review of set-up parameters for a given application.

5.2 CUSTOMER INTERFACE

The SemiChem APM 200 has been designed to fit within numerous process control environments. The system has a variety of outputs available, such as analog outputs/PLC handshaking, RS232 output, and Ethernet output.

5.2.1 Analog Outputs

The SemiChem APM 200 has four analog outputs. Each output can be multiplexed for additional outputs. For instance, analog output 1 also doubles as output 5, 2, 6, and so forth. This is done to allow the SemiChem APM 200 to have any number of outputs while simplifying external wiring to the system.

The analog output scale is configured in [SERVICE] > [SETTINGS] > [ANALOG OUTPUTS].

In some circumstance, it is desirable to force the SemiChem APM 200's outputs, this can be done from the recipe screen. The SemiChem APM 200 provides a recipe to run through a series of voltage or currents depending on output configuration.

Analog outputs are updated at the completion of the analysis and are held until the next analysis.

The analog outputs are wired to the SemiChem APM 200 via the provided CPC connector. Please refer to the wiring diagram for the proper pin-out of the CPC connection.

5.2.2 PLC Handshaking/Recipe Selection

Used in conjunction with the analog outputs, the user can manipulate the SemiChem APM 200 through PLC handshaking techniques. The handshaking is in the form of dry relay contacts. When using the SemiChem APM 200 with a PLC, the SemiChem APM 200 becomes a "slave" to the PLC and will only start when signaled.

In addition to starting the SemiChem APM 200 remotely with a PLC, the user can also select which recipe is desired through a series of three customer provided relay contacts. Refer to the wiring diagram located in the appendix.

Recipes are assigned to the inputs through [SERVICE] > [SETTINGS] > Remote Trigger Inputs. Here the user can assign a recipe for a given input.

5.2.2.1 PLC HANDSHAKING PROCEDURE WITHOUT RECIPE SELECT

The following sequence is used with the user's PLC to control the SemiChem APM 200 without the recipe select feature.

Table 5.1: PLC handshaking without recipe select

STEP	ACTION
10	SemiChem APM 200 idle, "READY" contact relay closed.
20	Customer initiates a measurement by closing "START" relay.
30	SemiChem APM 200 begins analysis using default recipe, opens "READY" relay.
40	Customer's PLC recognizes loss of "READY" signal and waits for return.
50	SemiChem APM 200 completes analysis, updates analog, and RS232 outputs.
60	SemiChem APM 200 closes "READY" signal to indicate completion of analysis.
70	Customer's PLC recognizes "READY" signal and reads outputs.
80	SemiChem APM 200 returns to idle status.

5.2.2.2 PLC HANDSHAKING PROCEDURE WITH RECIPE SELECT

When using the recipe select feature, the user provides three relays. The state of these relays signals to the SemiChem APM 200 which recipe to use. The following table shows the recipe select relay combinations.

Table 5.2 PLC recipe select user relay combinations

	RELAY 1	RELAY 2	RELAY 3
Recipe 0	Open	Open	Open
Recipe 1	Closed	Open	Open
Recipe 2	Open	Closed	Open
Recipe 3	Closed	Closed	Open
Recipe 4	Open	Open	Closed
Recipe 5	Closed	Open	Closed
Recipe 6	Open	Closed	Closed
Recipe 7	Closed	Closed	Closed

The following sequence is used with the user's PLC to control the SemiChem APM 200 with the recipe select feature.

Table 5.3: PLC handshaking with recipe select

STEP	ACTION
10	SemiChem APM 200 idle, "READY" contact relay closed.
20	Customer closes relay combination according to desired recipe.
30	Customer initiates a measurement by closing "START" relay.
40	SemiChem APM 200 begins analysis using default recipe, opens "READY" relay.
50	Customer's PLC recognizes loss of "READY" signal and waits for return.
60	SemiChem APM 200 completes analysis, updates analog, and RS232 outputs.
70	SemiChem APM 200 closes "READY" signal to indicate completion of analysis.
80	Customer's PLC recognizes "READY" signal and reads outputs.
90	SemiChem APM 200 returns to idle status.

5.2.3 RS232 Communications

The SemiChem APM 200 can be controlled through the bi-directional RS232. The RS232 provides for inputs to the SemiChem APM 200 as well as data outputs. Refer to section 5 for the RS232 hardware configuration.

Communications with the SemiChem APM 200 can be performed with any terminal type of program such as Windows Hyperterminal. Communication with the SemiChem APM 200 is executed at 2400 Baud/8-bit/no parity/1 stop bit.

When in LOCAL or REMOTE modes, the analyzer will automatically transmit the latest analysis results as soon as they are available. When in COMPUTER mode, data will only be transmitted when requested.

5.2.3.1 RS232 INPUTS

The following inputs are available for the SemiChem APM 200.

Table 5.4: RS232 commands

a,XX	Start analysis (where XX indicates the desired recipe)
i	Sends analyzer identity
r	Sends latest analysis results
s	SemiChem APM 200 status

NOTE: Characters must be sent in lower case. Data sent by the SemiChem APM 200 is always terminated with the END_OF_FILE character (ASCII26).

5.2.3.2 RS232 OUTPUT

The RS232 output can be configured in the [SETTINGS] > [RS232 Options]. This allows the user to configure the output to show only the data that is required.

5.2.3.3 ETHERNET NETWORKING

The SemiChem APM 200 has the ability to be networked through its Ethernet port. However, because the Ethernet port allows the SemiChem APM 200 to be accessed from remote locations, only monitoring functions are available. A user is not able to manipulate the SemiChem APM 200 in any way.

The SemiChem APM 200 IP address is: 192.168.1.104. Because the SemiChem APM 200 uses an Ethernet Switch rather than a router, it does not have a dynamic IP address. Please refer to your IT specialist for assistance.

Below an example of the web page. It shows the outputs as well as the status of the SemiChem APM 200.

The web page allows the user to remotely view history files and download history files (as ZIP files).

```

Entegris-AIS
Software v2.508 ID:080510084351
WebInterface v1.001
00:10:33
Channel 1: F-
13499.9ppm
Channel 2: H2SO4
0.000ml
Channel 3: H2O2
0.0ppm
Channel 4: F-4
1.754ml
Channel 5: F-5
1.760ml
Channel 6: F-6
1.758ml
Channel 7:
1.774ml
Channel 8:
1.776ml
18:54:04 Logout.
18:54:04 Auto-Logout Performed
19:11:09 Login level:
passcode_superuser
20:11:09 Logout.
20:11:09 Auto-Logout Performed
22:59:22 Login level:
passcode_superuser
22:59:43 Reloaded: user.conf
23:00:03 Reloaded: user.conf
23:59:22 Logout.
23:59:22 Auto-Logout Performed
    
```

SECTION 6: SYSTEM DIAGRAMS AND MECHANICAL DRAWINGS

6.1 ILLUSTRATED PARTS GUIDE

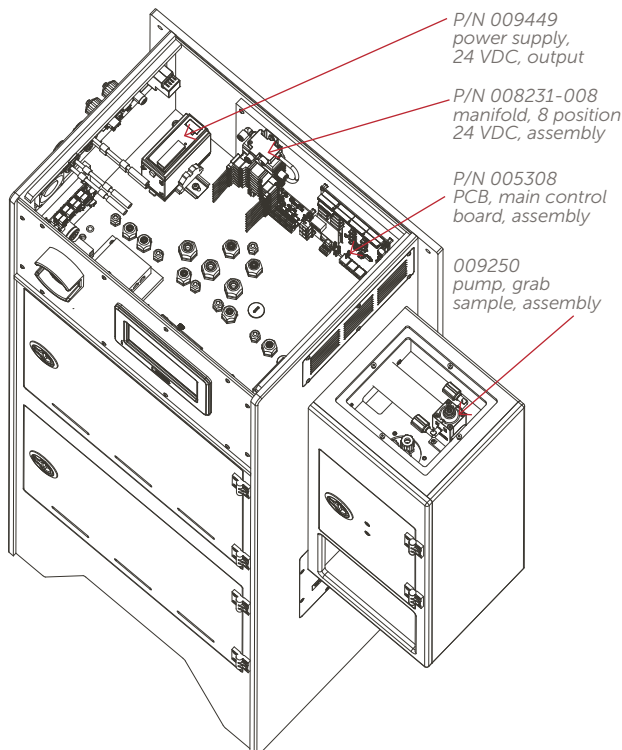
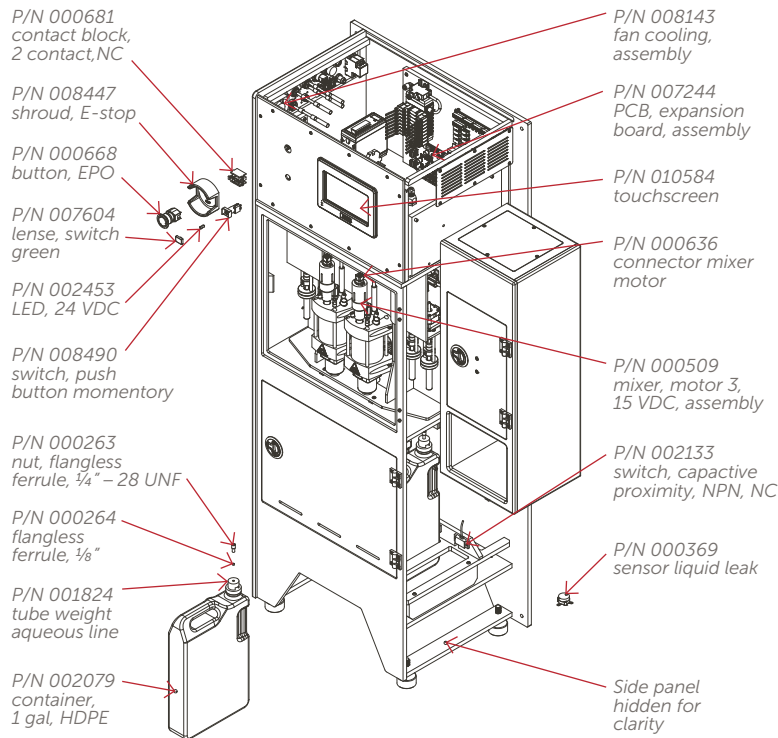

SEMICHEM APM 200, DUAL CELL FLOOR MOUNT WITH GRABPORT

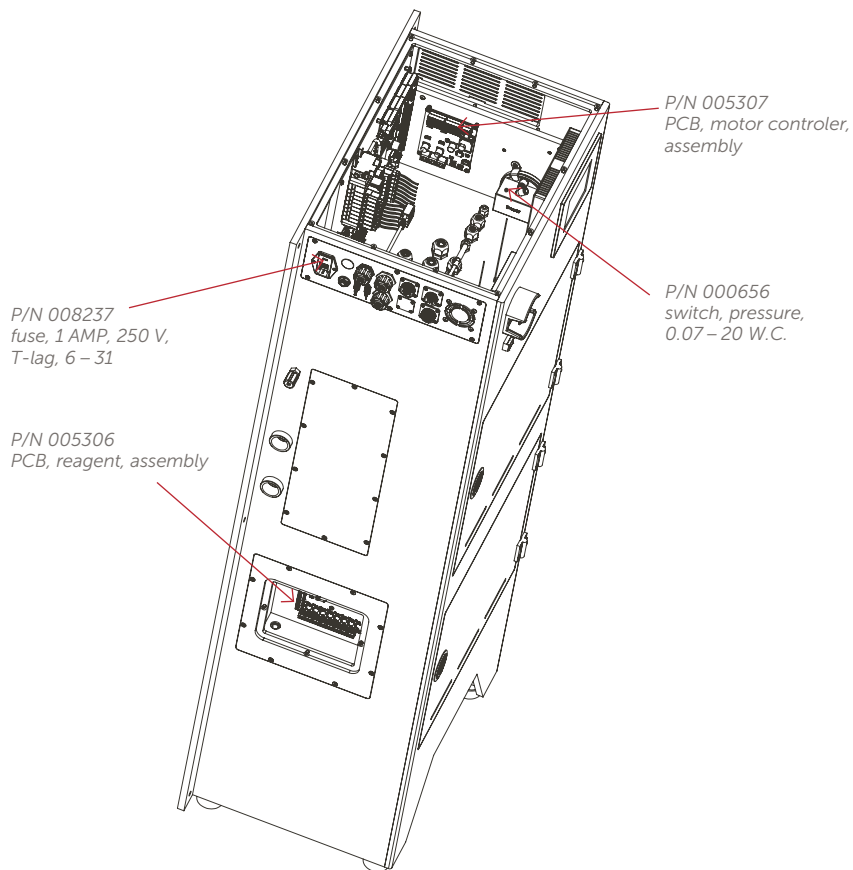
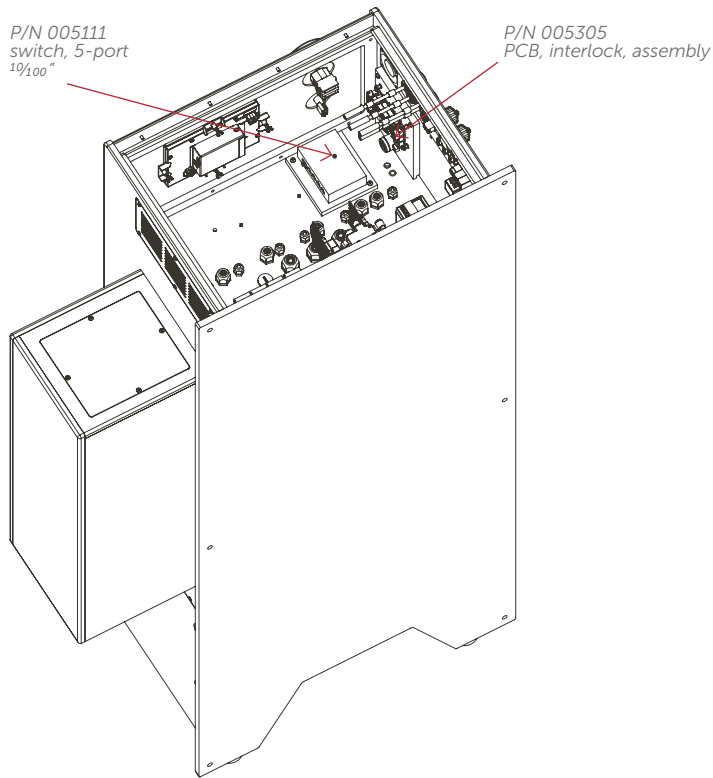

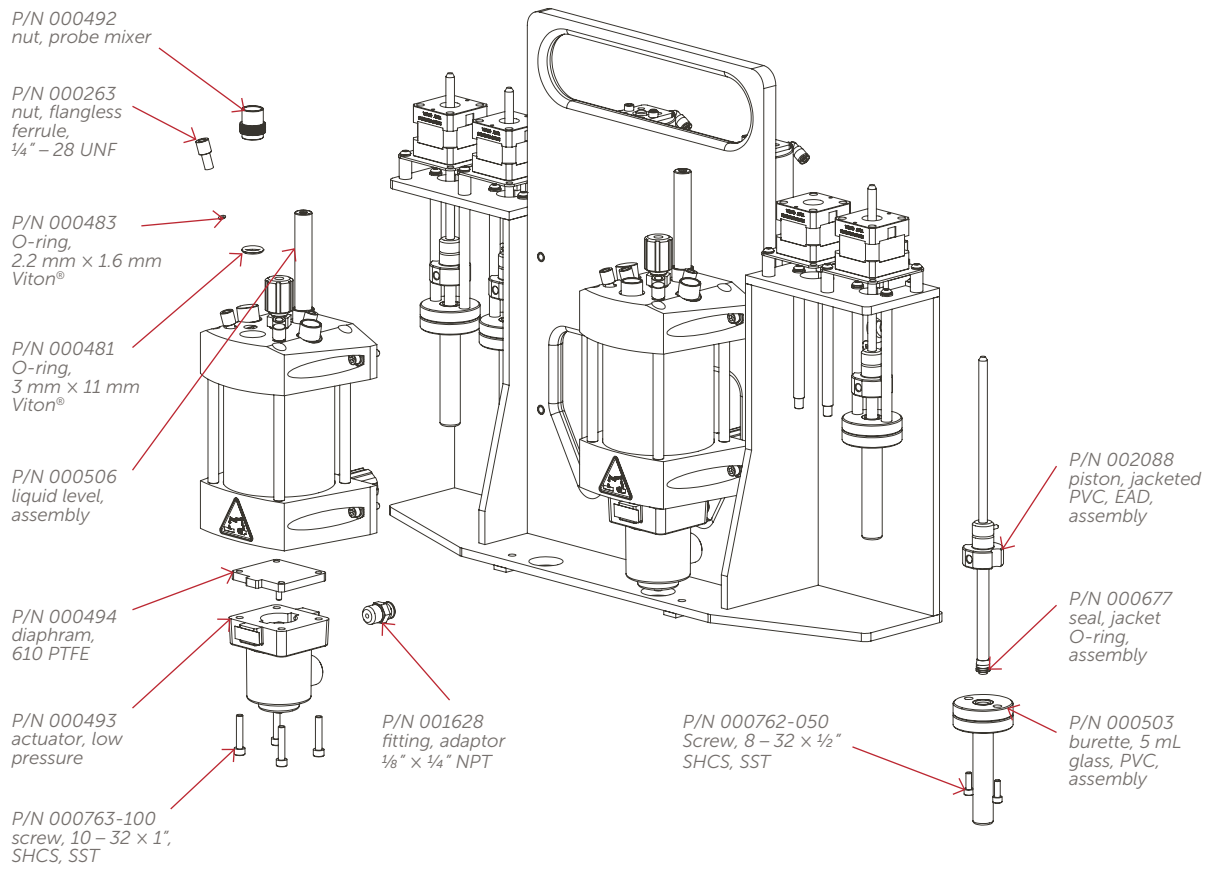

SEMICHEM APM 200, DUAL CELL FLOOR MOUNT WITH GRABPORT

P/N 000355
valve, 6-port with
actuator, assembly

P/N 001827
motor, servo
EAD, assembly

P/N 000261
sensor, photmicro
amplified, 5 – 15 VDC

P/N 005020
fitting, elbow
1/8" x 10 – 32 UNF

P/N 000289
cable, molded

P/N x001089
fitting, adaptor
1/2" NPT x 1/2" tube

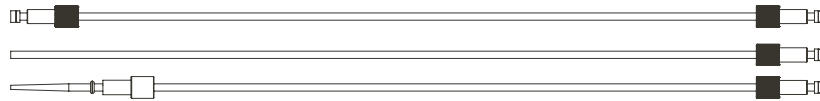
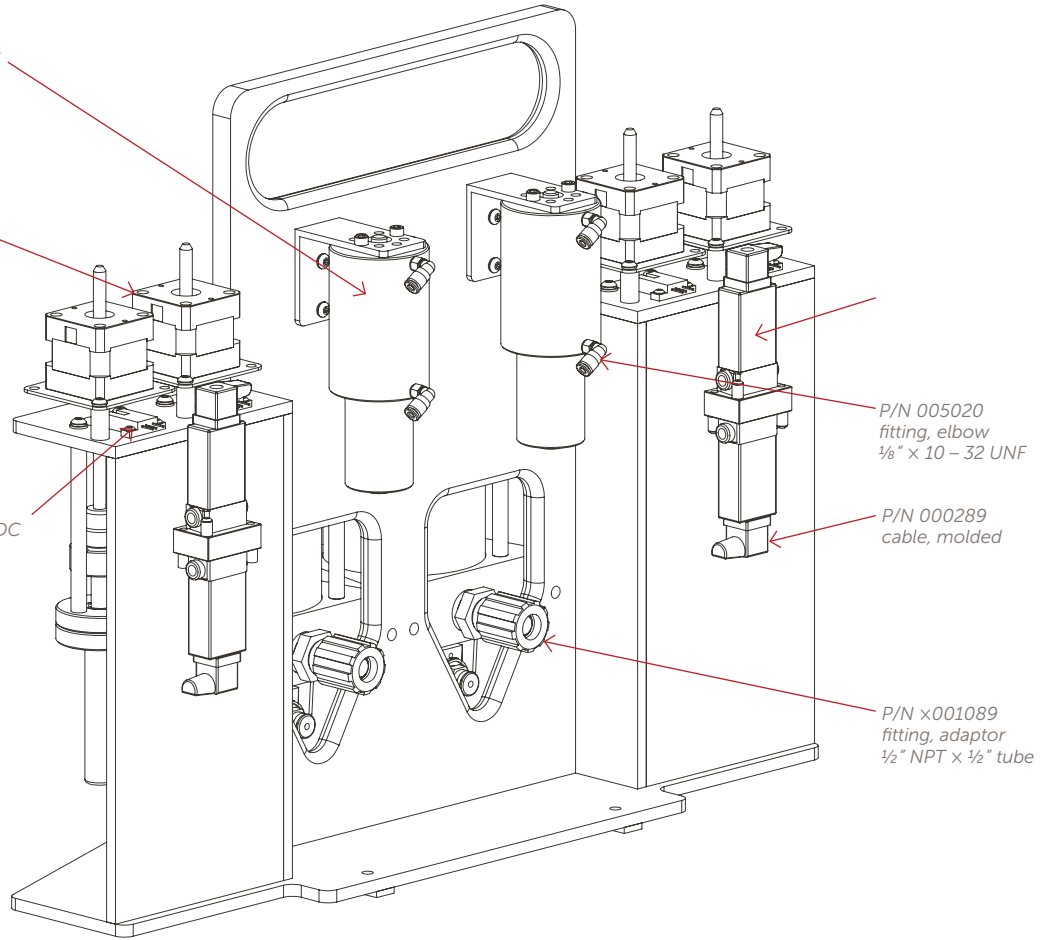

P/N 003649
Tube set, assembly

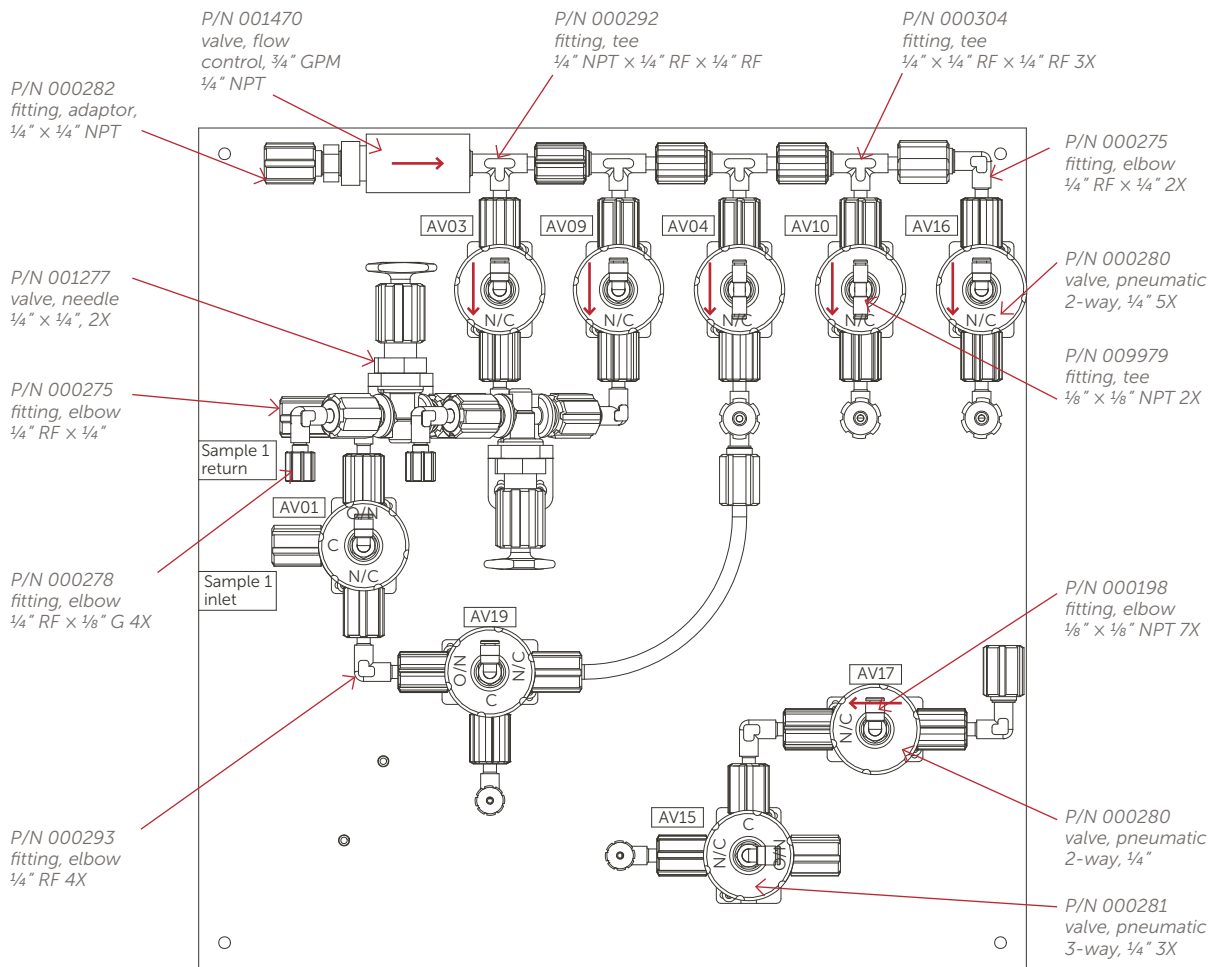

P/N 007987 Second Sample Option

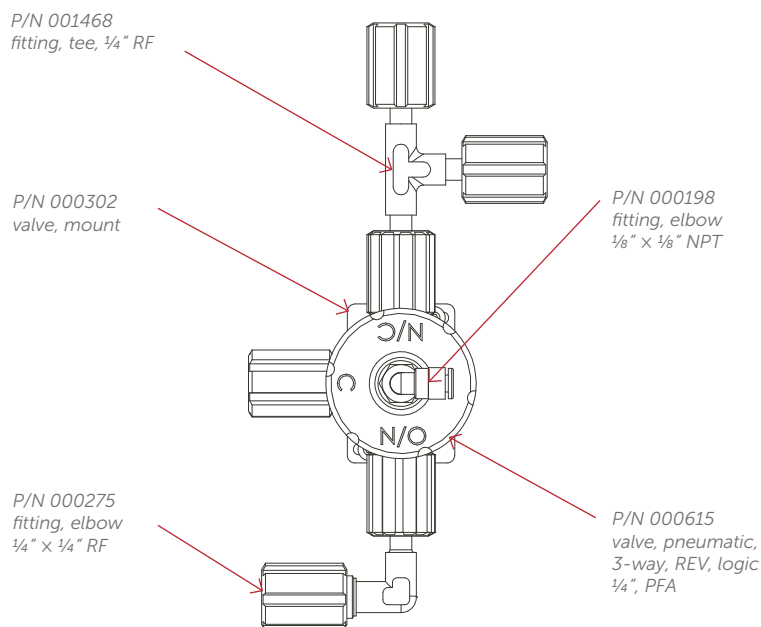

6.2 FACILITY DRAWING

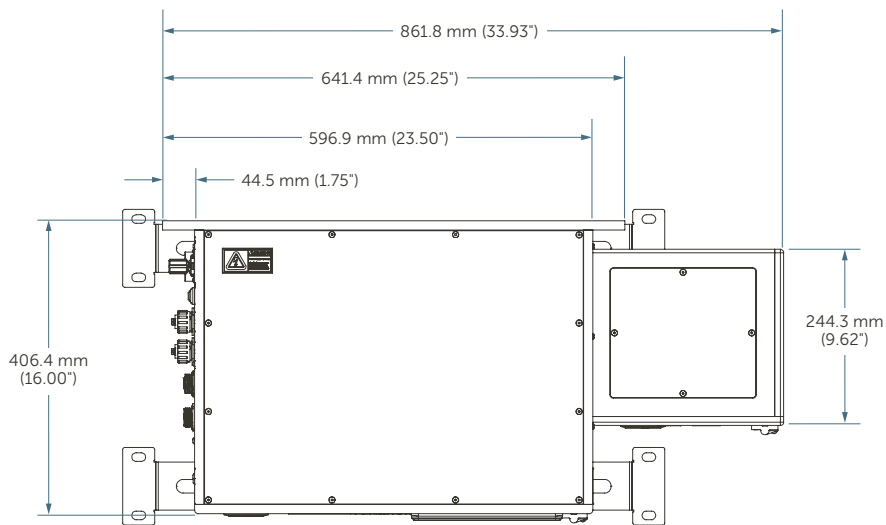
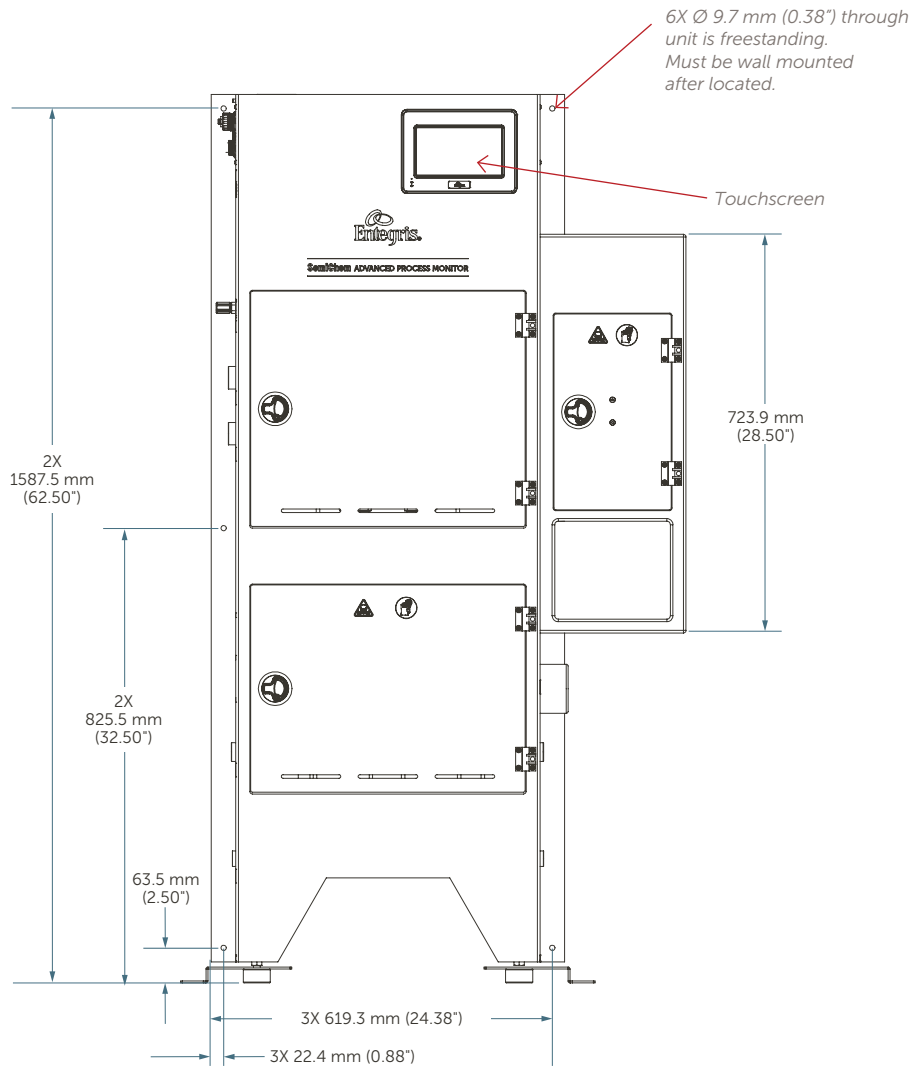

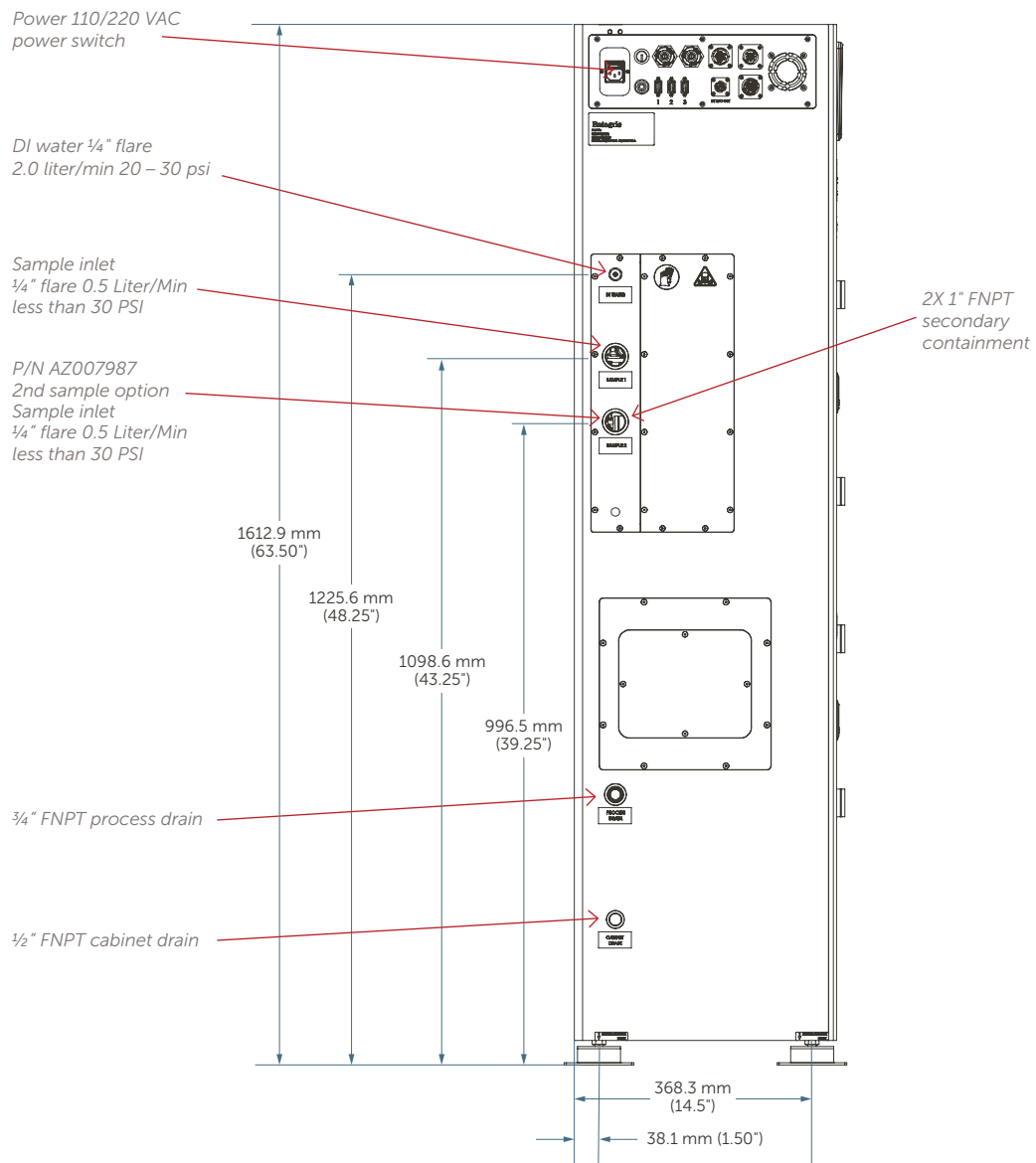

SEMICHEM APM 200, DUAL CELL FLOOR MOUNT WITH GRABPORT

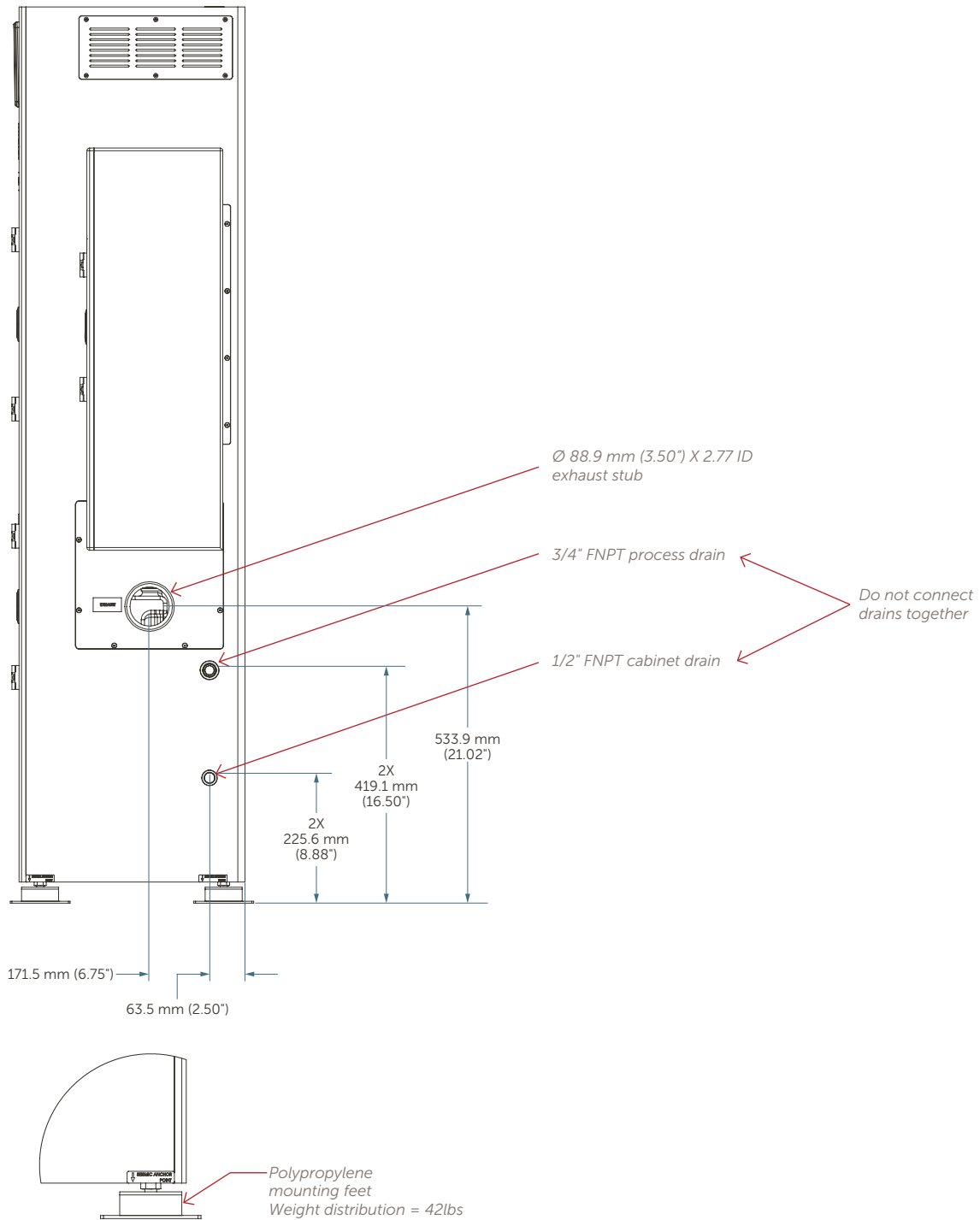

NOTE: System weight is 169 lbs (77 kg). Use mounting bracket Zoro Quakehold High Z Bracket, 1" SST (or equivalent). Wall mounting bolts: 3/8" - 16UNC 2A.

6.3 WIRING DIAGRAM – AZ011068 "STANDARD"

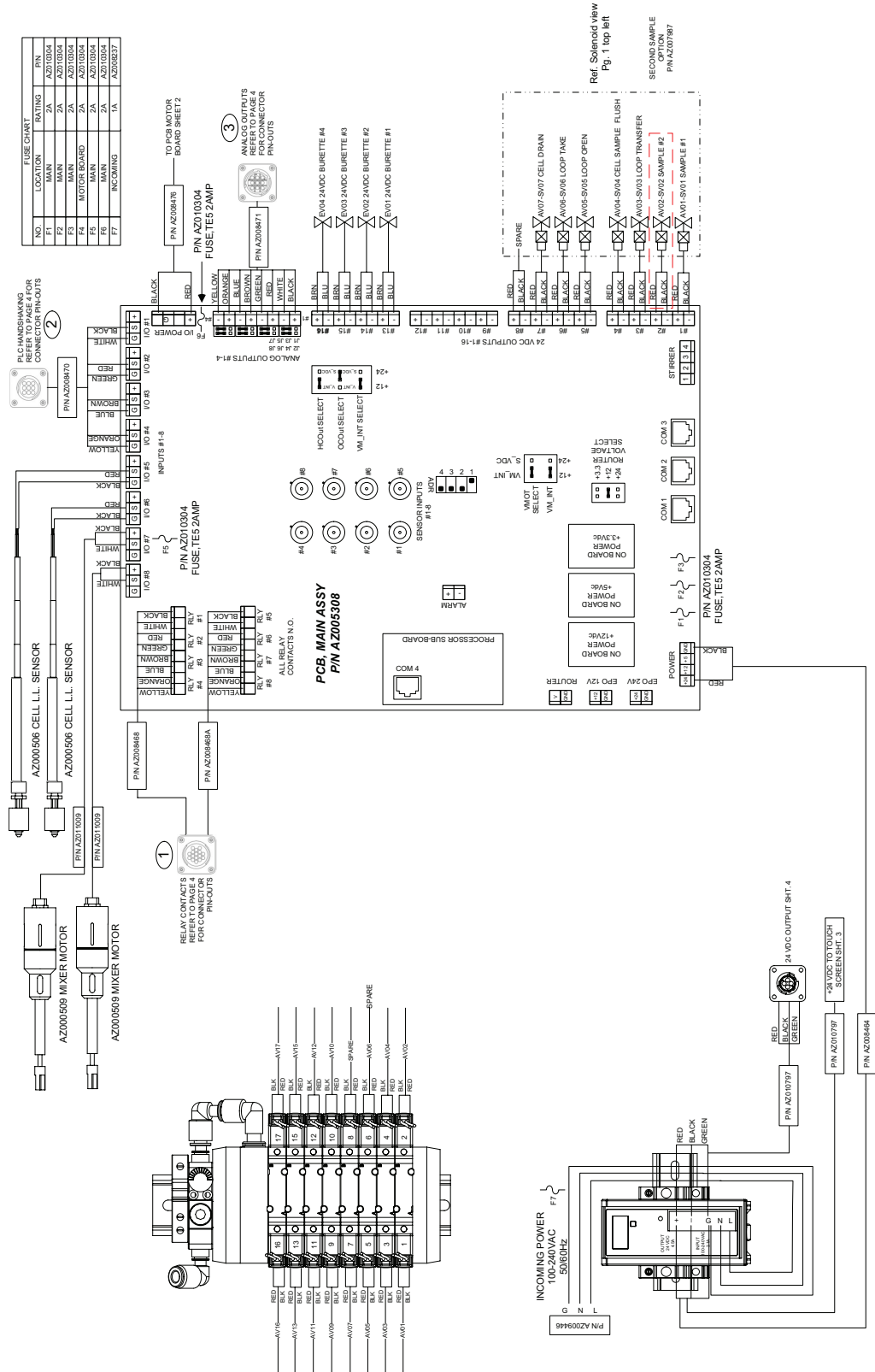

Ref. Schematic view Fig. 1 top left

SECOND SAMPLE PIN AZ00797

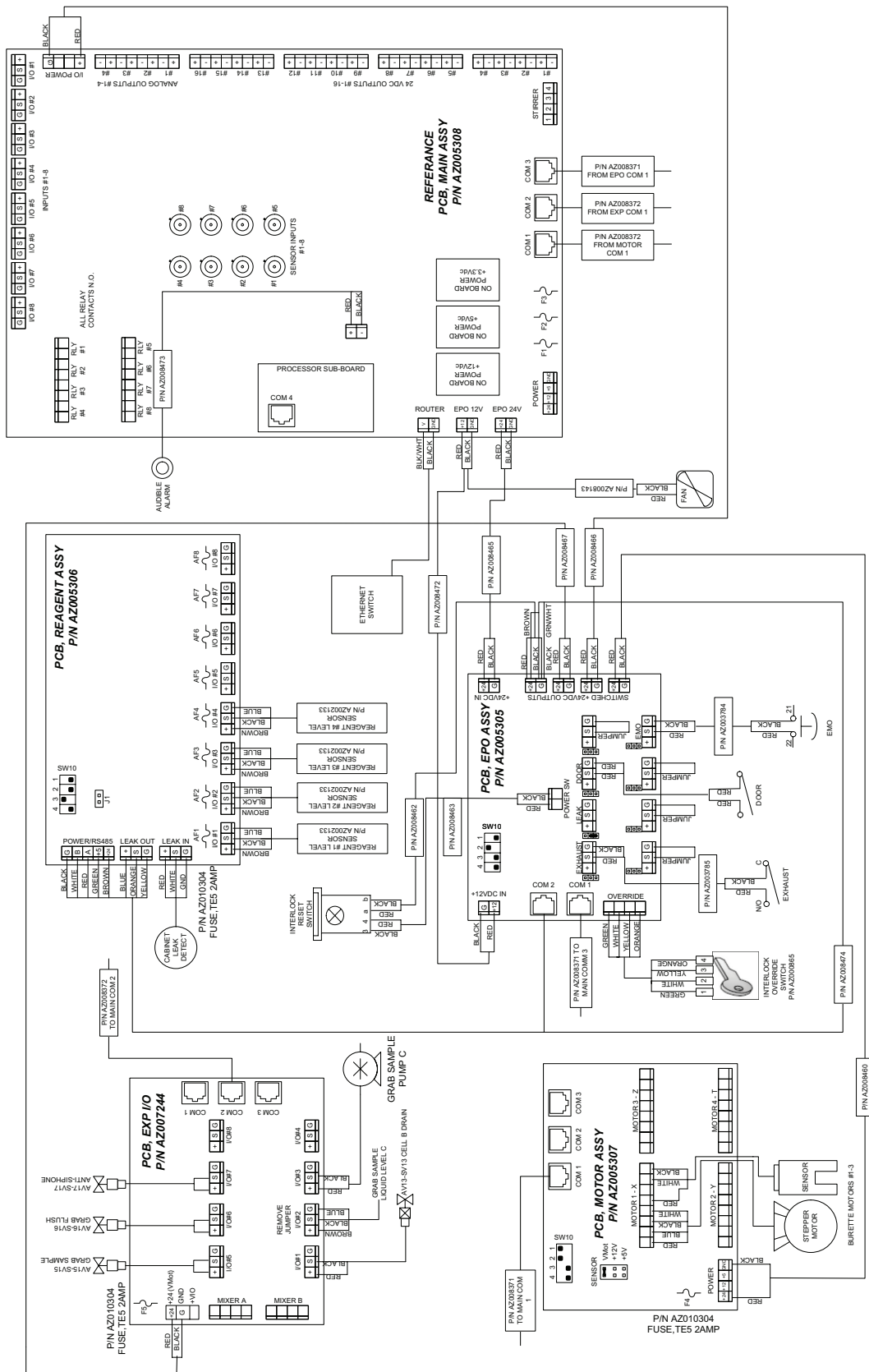

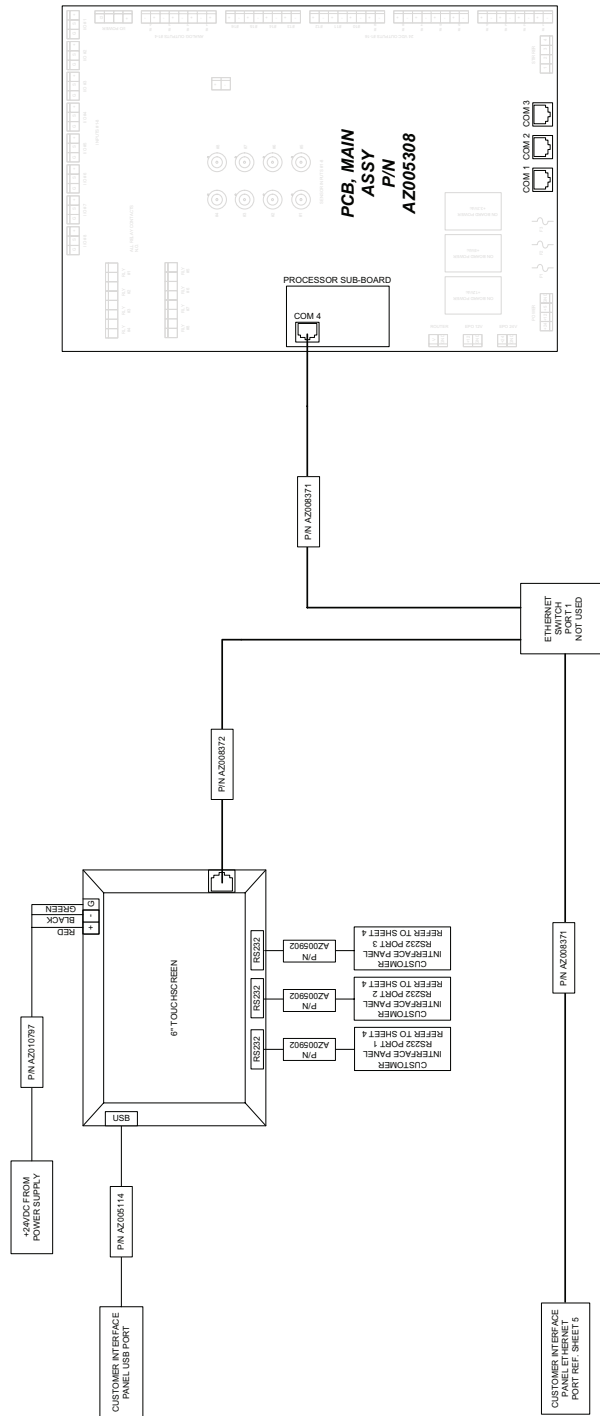

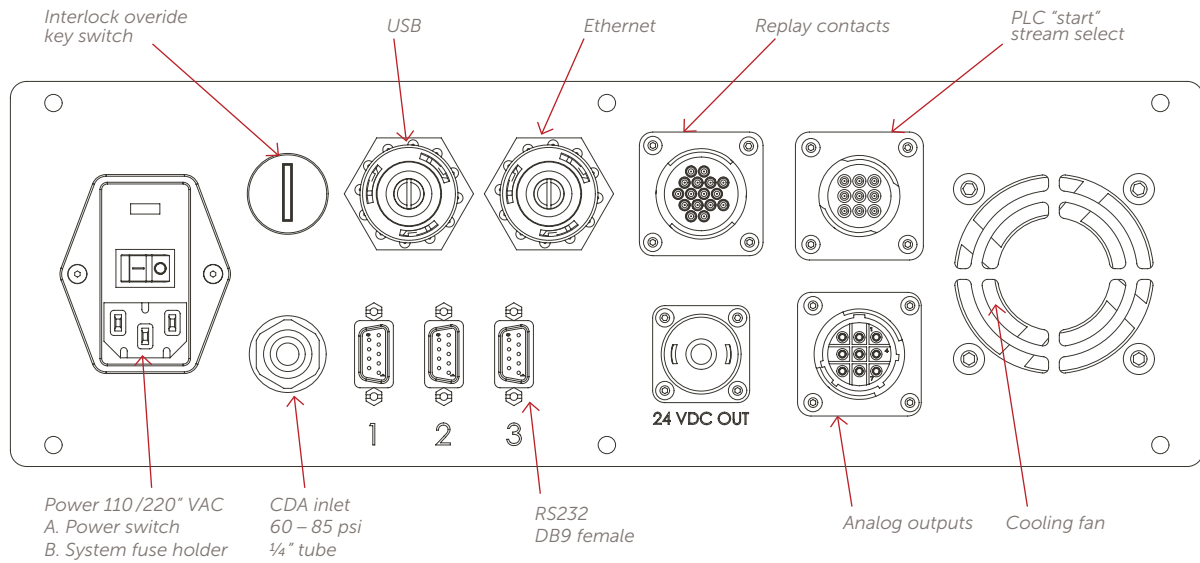

RELAY CONTACTS

	16-pin connector	Outputs	Main PCB terminals
Cable AZ008468	1 black	Relay 1 (analyzer ready)	RELOUT1-1
	2 white	Relay 1 (analyzer ready)	RELOUT1-2
	3 red	Relay 2 (interlock failure)	RELOUT1-3
	4 green	Relay 2 (interlock failure)	RELOUT1-4
	5 brown	Relay 3	RELOUT1-5
	6 blue	Relay 3	RELOUT1-6
	7 orange	Relay 4	RELOUT1-7
	8 yellow	Relay 4	RELOUT1-8
Cable AZ008468A	9 black	Relay 5	RELOUT2-1
	10 white	Relay 5	RELOUT2-2
	11 red	Relay 6	RELOUT2-3
	12 green	Relay 6	RELOUT2-4
	13 brown	Relay 7	RELOUT2-5
	14 blue	Relay 7	RELOUT2-6
	15 orange	Relay 8	RELOUT2-7
	16 yellow	Relay 8	RELOUT2-8

PLC HANDSHAKING

	9-pin connector	Inputs	Main PCB terminals
Cable AZ008470	1 black	RCP select bit 1	I/O#1-S
	2 white	RCP select bit 1	I/O#1-G
	3 red	RCP select bit 2	I/O#2-S
	4 green	RCP select bit 2	I/O#2-G
	5 brown	RCP select bit 3	I/O#3-S
	6 blue	RCP select bit 3	I/O#3-G
	7 orange	Analyzer start bit	I/O#4-S
	8 yellow	Analyzer start bit	I/O#4-G

ANALOG OUTPUTS

	9-pin connector	Outputs	Main PCB terminals
Cable AZ008471	1 black	4-20mA 1	DACOUT-1
	2 white	4-20mA 1	DACOUT-2
	3 red	4-20mA 2	DACOUT-3
	4 green	4-20mA 2	DACOUT-4
	5 brown	4-20mA 3	DACOUT-5
	6 blue	4-20mA 3	DACOUT-6
	7 orange	4-20mA 4	DACOUT-7
	8 yellow	4-20mA 4	DACOUT-8

6.4 WIRING DIAGRAM – AZ011496 "FM4910" AND "NON-FM4910"

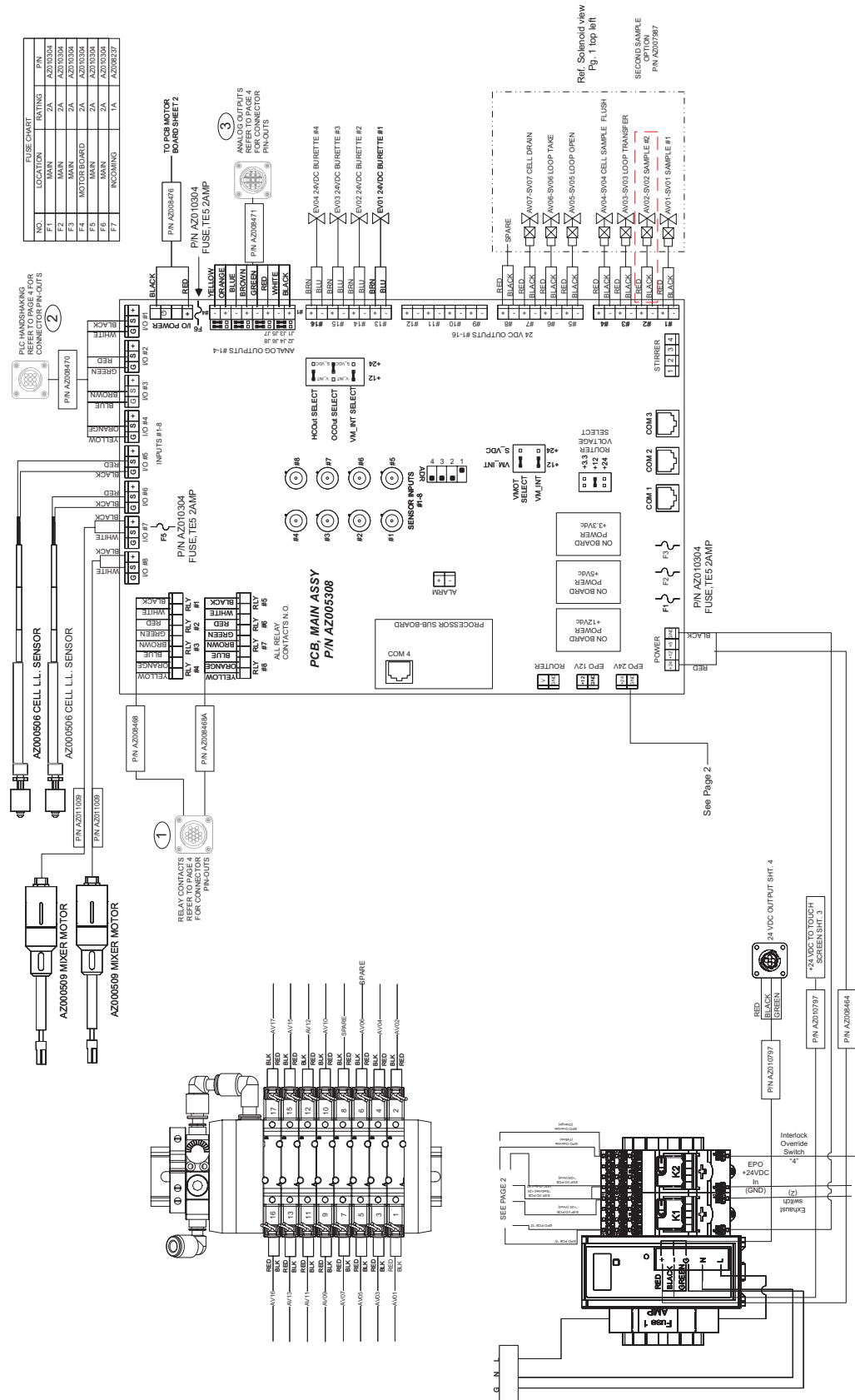

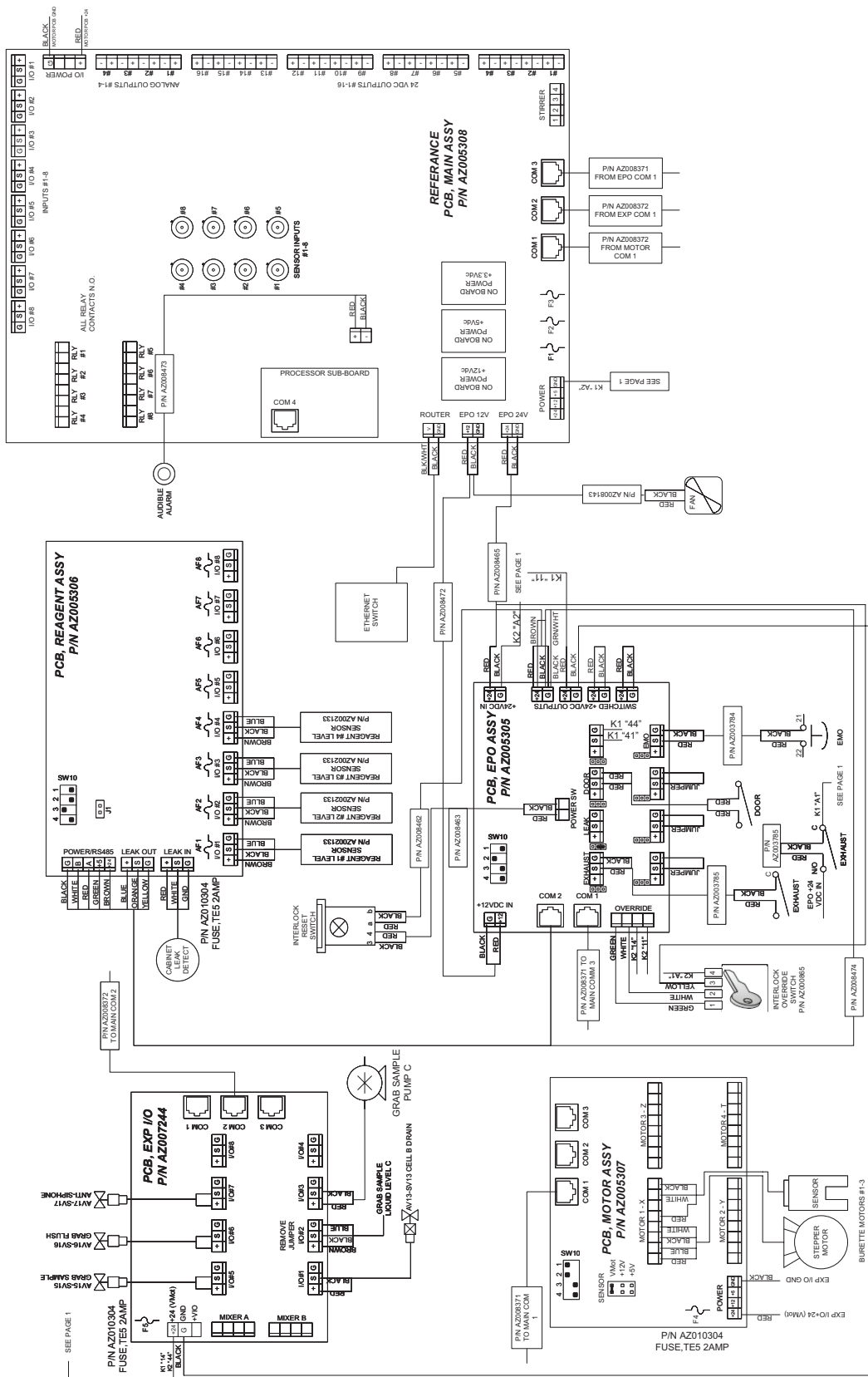

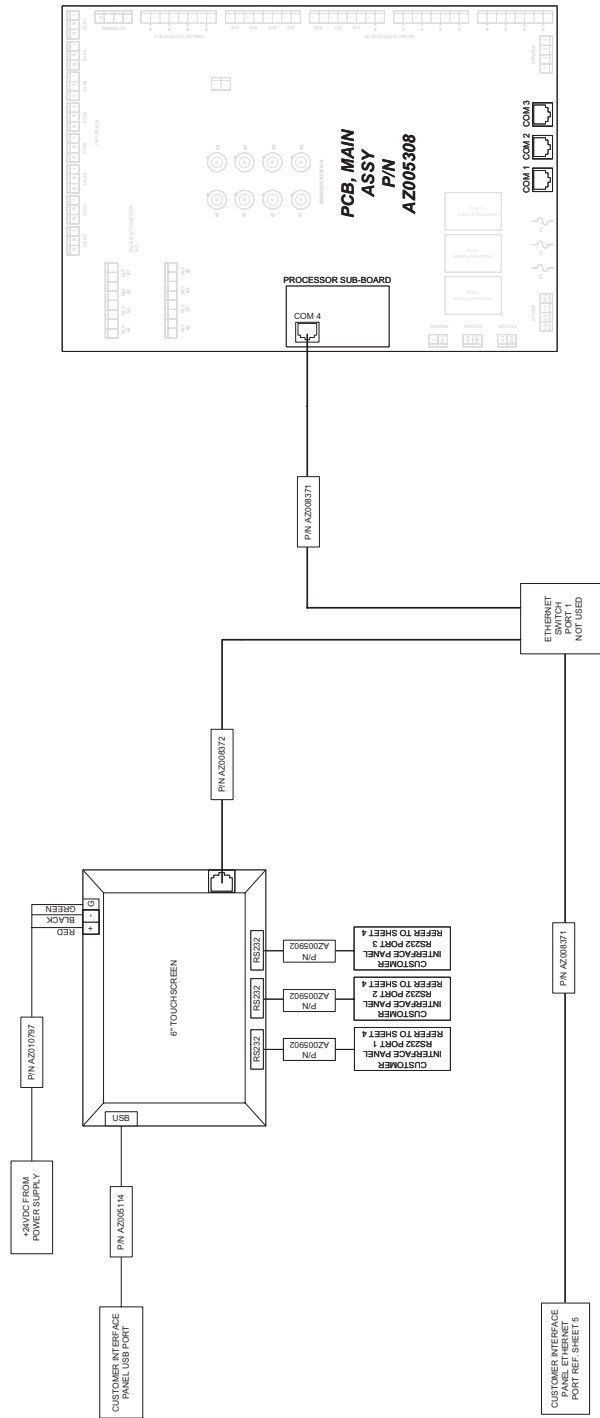

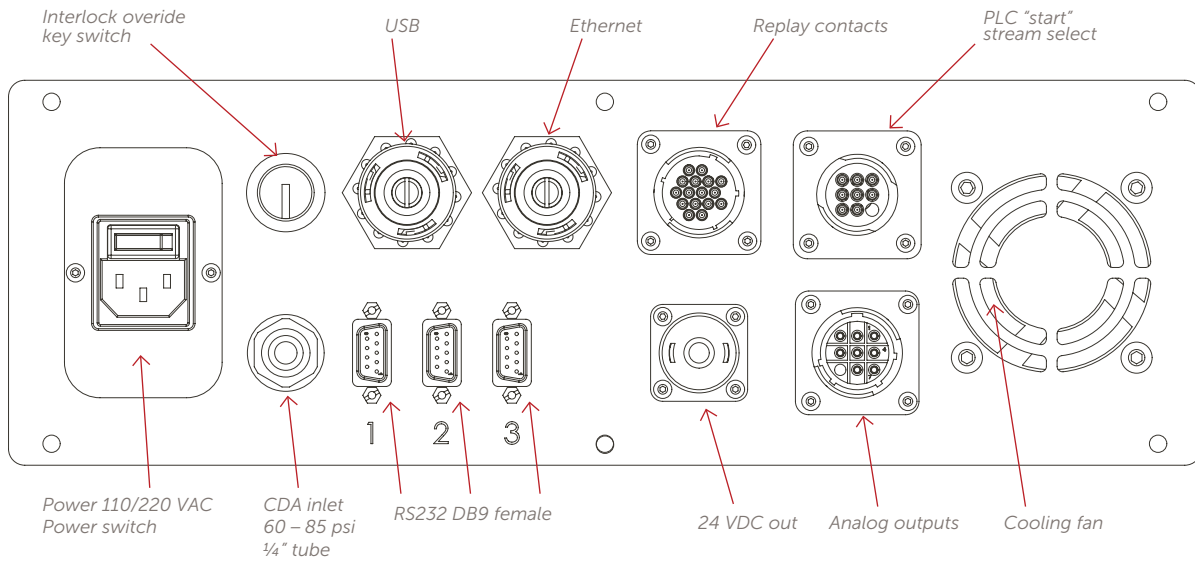

RELAY CONTACTS

	16-pin connector	Outputs	Main PCB terminals
Cable AZ008468	1 black	Relay 1 (analyzer ready)	RELOUT1-1
	2 white	Relay 1 (analyzer ready)	RELOUT1-2
	3 red	Relay 2 (interlock failure)	RELOUT1-3
	4 green	Relay 2 (interlock failure)	RELOUT1-4
	5 brown	Relay 3	RELOUT1-5
	6 blue	Relay 3	RELOUT1-6
	7 orange	Relay 4	RELOUT1-7
	8 yellow	Relay 4	RELOUT1-8
Cable AZ008468A	9 black	Relay 5	RELOUT2-1
	10 white	Relay 5	RELOUT2-2
	11 red	Relay 6	RELOUT2-3
	12 green	Relay 6	RELOUT2-4
	13 brown	Relay 7	RELOUT2-5
	14 blue	Relay 7	RELOUT2-6
	15 orange	Relay 8	RELOUT2-7
	16 yellow	Relay 8	RELOUT2-8

PLC HANDSHAKING

	9-pin connector	Inputs	Main PCB terminals
Cable AZ008470	1 black	RCP select bit 1	I/O#1-S
	2 white	RCP select bit 1	I/O#1-G
	3 red	RCP select bit 2	I/O#2-S
	4 green	RCP select bit 2	I/O#2-G
	5 brown	RCP select bit 3	I/O#3-S
	6 blue	RCP select bit 3	I/O#3-G
	7 orange	Analyzer start bit	I/O#4-S
	8 yellow	Analyzer start bit	I/O#4-G

ANALOG OUTPUTS

	9-pin connector	Outputs	Main PCB terminals
Cable AZ008471	1 black	4-20mA 1	DACOUT-1
	2 white	4-20mA 1	DACOUT-2
	3 red	4-20mA 2	DACOUT-3
	4 green	4-20mA 2	DACOUT-4
	5 brown	4-20mA 3	DACOUT-5
	6 blue	4-20mA 3	DACOUT-6
	7 orange	4-20mA 4	DACOUT-7
	8 yellow	4-20mA 4	DACOUT-8

SECTION 7: MAINTENANCE

The SemiChem APM 200 will provide years of trouble-free service. This section details the maintenance requirements to ensure maximum reliability and longevity. Routine analyzer maintenance requires 20 – 30 minutes per month. System maintenance includes:

- Weekly maintenance
- Monthly maintenance
- Quarterly maintenance

⚠ NOTICE: Please check with on-site EHS to ensure the appropriate PPE is used while conducting maintenance on the SemiChem APM 200.

⚠ NOTICE: Many service functions may require you to violate one or more of the safety interlock features of the SemiChem APM 200 or the process tool. This may cause your process to be interrupted due to automatic intervention by safety systems. Be sure you fully understand how the safety interlocks function and their impact on the processing tools.

7.1 PREVENTIVE MAINTENANCE

7.1.1 Weekly Maintenance

1. Visually inspect reagent levels (including sensor electrolyte); replenish as necessary.
2. Inspect dispensers (burettes) and dispenser tubing for air bubbles; flush as necessary.
3. Visually inspect sample panels and reaction vessels for evidence of leaks.
4. Observe a complete analysis cycle to confirm correct operation.

7.1.2 Monthly Maintenance

As per weekly PM, plus...

1. Calibrate the pH electrode (if installed) using pH₄ and pH₁₀ buffer solutions. The electrode's slope should be within the range 50 – 65; if not, repeat the calibration with fresh buffer solution. If the slope or offset remain out of specification, replace the pH electrode and calibrate. Refer to your Application Guide for complete details on electrode calibration.

7.1.3 Quarterly Maintenance

As per monthly PM, plus.

1. Replace all burette O-rings (if equipped with Viton O-ring), being careful to use the correct material type. Refer to heading 7.2, Replacing the Burette O-rings.
2. Verify all safety interlocks are working correctly.

7.1.4 Annual Maintenance

As per quarterly PM, plus.

1. Replace the electrode(s). Be sure to calibrate the electrodes prior to use. Refer to your Application Guide for complete details on electrode calibration.
2. Replace the jacketed style burette O-rings (if equipped). Refer to heading 7.3, Replacing the Jacketed Style Burette O-rings.

7.1.5 Bi-annual Maintenance

As per annual PM, plus.

1. Replace the 6-port valve head.

7.2 REPLACING THE BURETTE O-RINGS

As indicated by the PM schedules, replacement of the burette O-rings is required quarterly. This will ensure that all of the burettes operate trouble free for the life of your SemiChem APM 200.

To replace the analyzer's O-rings you will need:

- The 3/4" ball driver (003642) that was provided in your start-up kit.
- The O-ring removal tool (003640 and 003641) that was provided in your start-up kit.
- Up to four 2 mm x 6 mm burette O-rings (000484).
- Silicone paste kit (002691).
- Absorbent cleanroom wipes.
- About 30 minutes of time.

Since you will be performing service on the analyzer, be aware of the potential hazards associated with the SemiChem APM 200. For more details see Section 2, Safety.

⚠ WARNING: Corrosive or poisonous liquids. Some reagents may be corrosive to the eyes, skin, and respiratory tract and may be hazardous if ingested. Wear chemical resistant gloves, face shield, and apron when changing the burette O-ring. See MSDS for further health hazard information. To minimize chemical exposure, purge the burette with air by removing the reagent intake line from the reagent bottle, then flush the appropriate burette. This will remove most of the reagent from the burette assembly. If replacing the burette glass, consult with on-site environmental personnel for proper disposal of remaining reagents. If replacing a burette O-ring, keep the burette glass assembly within the enclosure for proper exhaust of fumes.



The procedure for replacing a burette O-ring is as follows:

1. From the MAIN screen, wait until the current analysis cycle has finished.
2. Press "Stop Continuous" to place the SemiChem APM 200 in standby mode.
3. Using the maintenance key, switch the SemiChem APM 200 into maintenance mode which will bypass the safety interlocks.
4. Starting with burette #1 (left-most burette), remove the two #8 – 32 x 1/2" screws from underneath the collar of the burette glass assembly using the ball driver provided.
5. Give the burette glass a gentle downward tug to pull it off. Take care to minimize the amount of reagent that spills out. An absorbent wipe is useful for catching any spills/drips.
6. Using the O-ring removal tool, carefully pull off the existing O-ring. Be sure to dispose of this O-ring as chemical-contaminated waste.
7. Put the new O-ring in place on the groove of the piston. Be sure it is seated properly.
8. Using the supplied applicator, wipe a small amount of silicon paste lubricant onto the O-ring.
9. Reattach the burette glass assembly using the screws and ball driver.
10. Perform the same procedure for the remaining burettes.

11. From the [SERVICE] screen, press "Recipes," within the recipe window scroll down and find "Flush All Burettes". Select this recipe and press "Run Now." All four burette will cycle up and down three times to flush any air bubbles out of the system.
12. Find the recipe "Empty Cell" and press "Run Now." The cell will completely drain.
13. Find the recipe, "Flush Cell" and press "Run Now" and the cell will be flushed with DI water.

7.3 REPLACING THE JACKETED STYLE BURETTE O-RING

As indicated by the PM schedules, replacement of the burette O-rings is required on a quarterly basis. This will ensure that all of the burettes operate trouble-free for the life of your SemiChem APM 200.

To replace the analyzer's O-rings you will need:

- The 9/64" ball driver (003642) that was provided in your start-up kit.
- Up to four jacketed style burette O-rings (000677).
- Absorbent cleanroom wipes.
- About 30 minutes of time.

Since you will be performing service on the analyzer, be aware of the potential hazards associated with the SemiChem APM 200.

For more details see section 2, Safety.

⚠ WARNING: Corrosive or poisonous liquids. Some reagents may be corrosive to the eyes, skin, and respiratory tract and may be hazardous if ingested. Wear chemical resistant gloves, face shield, and apron when changing the burette O-ring. See MSDS for further health hazard information. To minimize chemical exposure, purge the burette with air by removing the reagent intake line from the reagent bottle, then flush the appropriate burette. This will remove most of the reagent from the burette assembly. If replacing the burette glass, consult with on-site environmental personnel for proper disposal of remaining reagents. If replacing a burette O-ring, keep the burette glass assembly within the enclosure for proper exhaust of fumes.



The procedure for replacing a burette O-ring is as follows:

1. From the MAIN screen, wait until the current analysis cycle has finished.
2. Press "Stop Continuous" to place the SemiChem APM 200 in standby mode.
3. Using the maintenance key, switch the SemiChem APM 200 into maintenance mode which will bypass the safety interlocks.
4. Starting with burette #1 (left-most burette), remove the two #8-32 x 1/2" screws from underneath the collar of the burette glass assembly using the ball driver provided.
5. Give the burette glass a gentle downward tug to pull it off. Take care to minimize the amount of reagent that spills out. An absorbent wipe is useful for catching any spills/drips.
6. Using your fingers, carefully pull off the existing O-ring. It may require some exertion to remove. Be sure to dispose of this O-ring as chemical-contaminated waste.
7. Place the new seal on your fingertip. Lift the seal onto the tip of the piston and push upwards. Once pressed partially onto the piston, continue to lift the seal until it "snaps" into place past the small bump at the tip of the piston. Be sure it is seated properly.
8. Reattach the burette glass assembly using the screws and ball driver.
9. Perform the same procedure for the remaining burettes.
10. From the [SERVICE] screen, press "Recipes," within the recipe window scroll down and find "Flush All Burettes". Select this recipe and press "Run Now." All four burette will cycle up and down three times to flush any air bubbles out of the system.
11. Find the recipe "Empty Cell" and press "Run Now." The cell will completely drain.
12. Find the recipe, "Flush Cell" and press "Run Now" and the cell will be flushed with DI water.

7.4 LOCK-OUT TAG-OUT

1. Notify the appropriate personal.
2. Hazardous energy sources are Electrical, Mechanical, Pneumatic, & Chemical
3. Press "Stop Single" or "Stop Continuous" depending on the SemiChem run configuration.
4. Place SemiChem in "Local" mode.
5. Shut off DI Water supply to SemiChem and affix isolation equipment in accordance with on-site Safety Engineers. Perform Lockout Tagout at the isolation equipment.
6. Shut off Chemical supply to SemiChem and affix isolation equipment in accordance with on-site Safety Engineers. Perform Lockout Tagout at the isolation equipment.
7. On SemiChem Diagnostics screen energize AV01 for 5 seconds, once the 5 seconds is finished deenergize AV01.
8. On SemiChem Diagnostics screen energize AV02 for 5 seconds, once the 5 seconds is finished deenergize AV02.
9. On SemiChem Diagnostics screen energize AV04 for 5 seconds, once the 5 seconds is finished deenergize AV04.
10. Shut off Air supply to SemiChem and affix isolation equipment in accordance with on-site Safety Engineers. Perform Lockout Tagout at the isolation equipment.
11. Turn SemiChem Power Switch to the off position.
12. Remove disconnect Power to SemiChem and affix isolation equipment in accordance with on-site Safety Engineers. Perform Lockout Tagout at the isolation equipment.
13. Turn SemiChem Power Switch to the on position. SemiChem should not energize.
14. Turn SemiChem Power Switch to the off position.
15. Remove affixed isolation equipment from Air supply. Remove Lockout Tag out.
16. Remove affixed isolation equipment from DI Water supply.
17. Remove affixed isolation equipment from Chemical supply. Remove Lockout Tag out.

18. Remove affixed isolation equipment from Power supply and reconnect.
19. Turn SemiChem Power Switch to the on position.
20. Return to normal operation.

7.5 SEMICHEM APM 200, DUAL CELL FLOOR MOUNT START-UP KIT

Line item	Part number	Description	Quantity
1	000263	Nut, flangeless, 1/4" – 28, PVDF	5
2	000264	Ferrule, flangeless, 1/8"	5
3	010388	Nut, flangeless, 1/4" – 28, PEEK™	5
4	010387	Ferrule, flangeless, 1/8", Tefzel®	5
5	000481	O-ring, 3 mm x 11 mm, Viton	2
6	000492	Nut, probe, mixer	1
7	001204	CPC pins	14
8	001205	CPC sockets	35
9	001491	Plug, STD sex, series 1.17 – 16	1
10	001492	CPC backshells	3
11	003636	Sample loop 0.25 mL, SC, assembly	1
12	003637	Sample loop 0.50 mL, SC, assembly	1
13	003635	Sample loop 2 mL, SC, assembly	1
14	003640	Hook tip wrench, O-ring removal	1
15	003641	Handle, aluminum	1
16	003642	Wrench, 9/64" ball end driver	1
17	008454	Plug, STD sex, series 1.17 – 9	1
18	008455	Plug, REV sex, series 1.17 – 9	1
19	010304	Fuse, board mount, 2A, slow	8
20	008237	Fuse, 1 Amp, 250 V, Tlag 6 x 31 mm	4
21	000762-050	Screw, 8 – 32 x 1/2", SHCS, stainless steel	5
22	000758-050	Screw, 8 – 32 x 1/2", FHCS, stainless steel	5
23	010651	Captive stylus with adhesive back holder	1
24	009251	Bottle, 500 mL, grab sample	5

LIMITED WARRANTY

Entegris' products are subject to the Entegris, Inc. General Limited Warranty. To view and print this information, visit entegris.com and select the [Legal & Trademark Notices](#) link in the footer. Entegris does not warrant any failure in the case of customers using unapproved foreign components.

FOR MORE INFORMATION

Please call your Regional Customer Service Center today to learn what Entegris can do for you. Visit entegris.com and select the [Contact Us](#) link to find the customer service center nearest you.

TERMS AND CONDITIONS OF SALE

All purchases are subject to Entegris' Terms and Conditions of Sale. To view and print this information, visit entegris.com and select the [Terms & Conditions](#) link in the footer.



Corporate Headquarters

129 Concord Road
Billerica, MA 01821
USA

Customer Service

Tel +1 952 556 4181
Fax +1 952 556 8022
Toll Free 800 394 4083

Entegris®, the Entegris Rings Design®, and other product names are trademarks of Entegris, Inc. as listed on entegris.com/trademarks. All third-party product names, logos, and company names are trademarks or registered trademarks of their respective owners. Use of them does not imply any affiliation, sponsorship, or endorsement by the trademark owner.

©2013-2023 Entegris, Inc. | All rights reserved. | Printed in the USA | 7133-11470ENT-1123